

Campus Networking Best Practices

Session 3: Layer 0 Campus Network Structured Cabling

Dale Smith
University of Oregon & NSRC
dsmith@uoregon.edu

We all have some ugly wiring

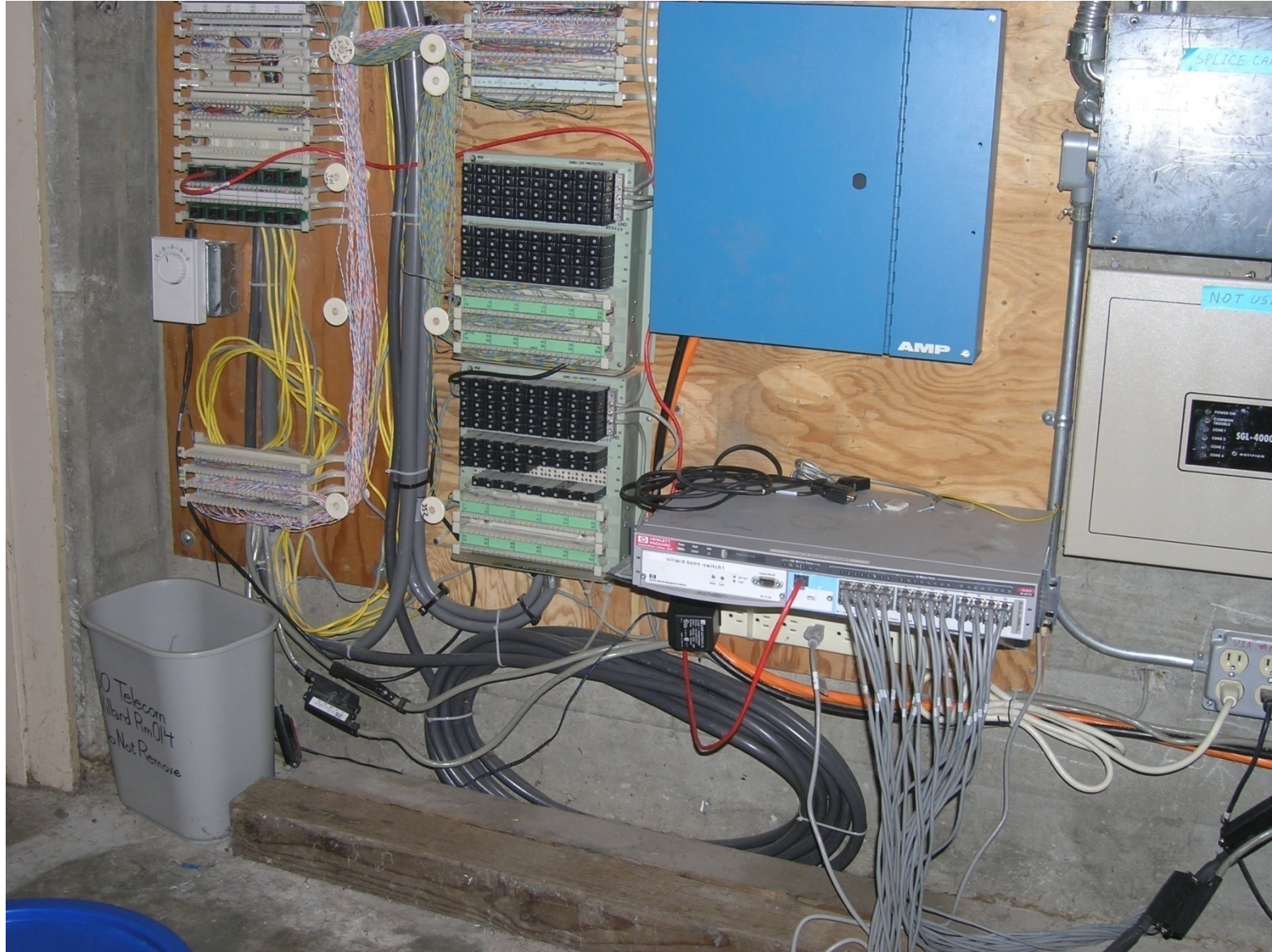

Structured Cabling Systems

- Only two types of cabling:
 - Unshielded twisted pair copper – provides service to individual computers and between network closets
 - Fiber optic cabling – provides service to buildings and between network closets
- Everything is run in a star configuration

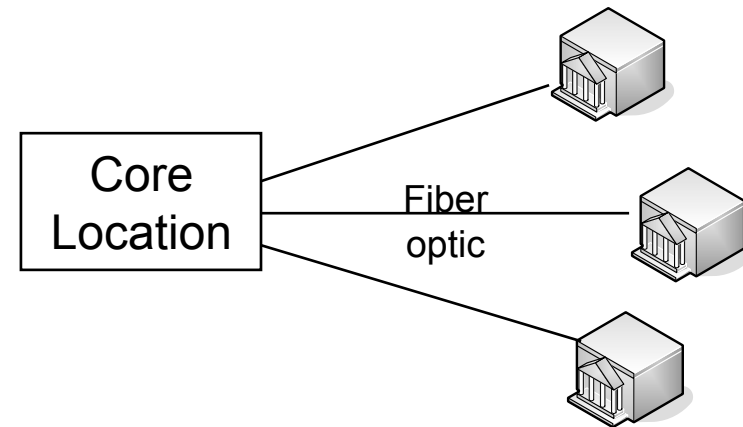
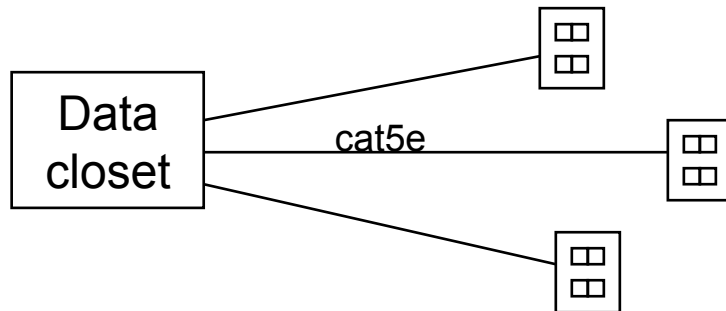

Unshielded Twisted Pair Cable

- Run in star configuration from Network Closet location to individual outlets in offices or labs.
- Run at least two cables to every outlet – I recommend four if you can afford it.
- Run at least six cables between network closets if the distance is less than 90 meters
- Question: what type of cable to run? Cat5, cat5e, Cat6, ???

What type of UTP

- What speed does each type support?

Cable Type	Max Speed	Max Distance	Cost Factor
Category 5	100Mbps	100m	1x
Category 5e	1000Mbps	100m	1x
Category 6	1000Mbps	100m	1.3x
Category 6	10,000Mbps	57m	1.3x
Category 6a	10,000Mbps	100m	2x

- Strongly recommend category 5e cabling.

Unshielded Twisted Pair Cable

- Labeling is a key to reduce work later



Fiber Optic Cabling

- Two basic types of fiber
 - Multi Mode limited to 2km @ 100Mbps
 - Single Mode 70km @ virtually unlimited
- Multiple types of multi mode
 - 62.5 micron core
 - 50 micron core
- Multiple types of single mode
 - Optimized for 1310 and 1550 nm operation
 - Optimized for WDM operation

Physics of Fiber

What type of Fiber?

- Multi mode Fiber
 - 62.5 micron
 - 100baseFX for 2km, optical interface cost \$250 USD
 - 1000baseSX for 275m, optical interface cost \$250 USD
 - 1000baseLX for 500m, optical interface cost \$750 USD
 - 10GbaseSR for 33m, optical interface cost \$2000 USD
 - 10GbaseLRM for 220m, optical interface cost \$1500 USD (not widely avail)
 - 50 micron laser optimized
 - 100baseFX for 2km, optical interface cost \$250 USD
 - 1000baseSX for 550m, optical interface cost \$250 USD
 - 1000baseLX for 500m, optical interface cost \$750 USD
 - 10GbaseSR for 300m, optical interface cost \$2000 USD
 - 10GbaseLRM for 220m, optical interface cost \$1500 USD (not widely avail)
- Single mode Fiber
 - 100baseFX not supported
 - 1000baseSX not supported
 - 1000baseLX for 5km (most vendors support 10km), cost \$750 USD
 - 1000baseLH (not a standard) 70 km with 1550nm lasers, cost \$3000 USD
 - 10GbaseLR for 10km, optical interface cost \$3000 USD
 - 10GbaseER for 30-40km, optical interface cost \$8500 USD

Going Fast on Fiber

- Multi mode Fiber
 - 62.5 micron
 - 1Gbs to 500m
 - 10Gbs to 220m
 - 50 micron laser optimized
 - 1Gbs to 500m
 - 10Gbs to 300m
- Single mode Fiber
 - 1Gbs to 70km
 - 10Gbs to 70km

Fiber Optic Topology

- Need to install both Multi and Single Mode
 - Multi mode: either 62.5 or 50 micro is acceptable
 - Single mode: use fiber optimized for 1310/1550nm
- Run in star configuration from core network location to individual buildings
- Also run in star configuration inside of buildings from main phone closet to other closets
- To reduce costs, can run large fiber cable from core to some remote location, then smaller cables from there to surrounding buildings

Star Configuration

- Plan for future -- Install enough fiber
 - Minimum: 6 multimode plus 6 single mode from core to each building
 - Minimum: 6 multimode plus 6 single mode from building entrance network closet to every other network closet in the building.

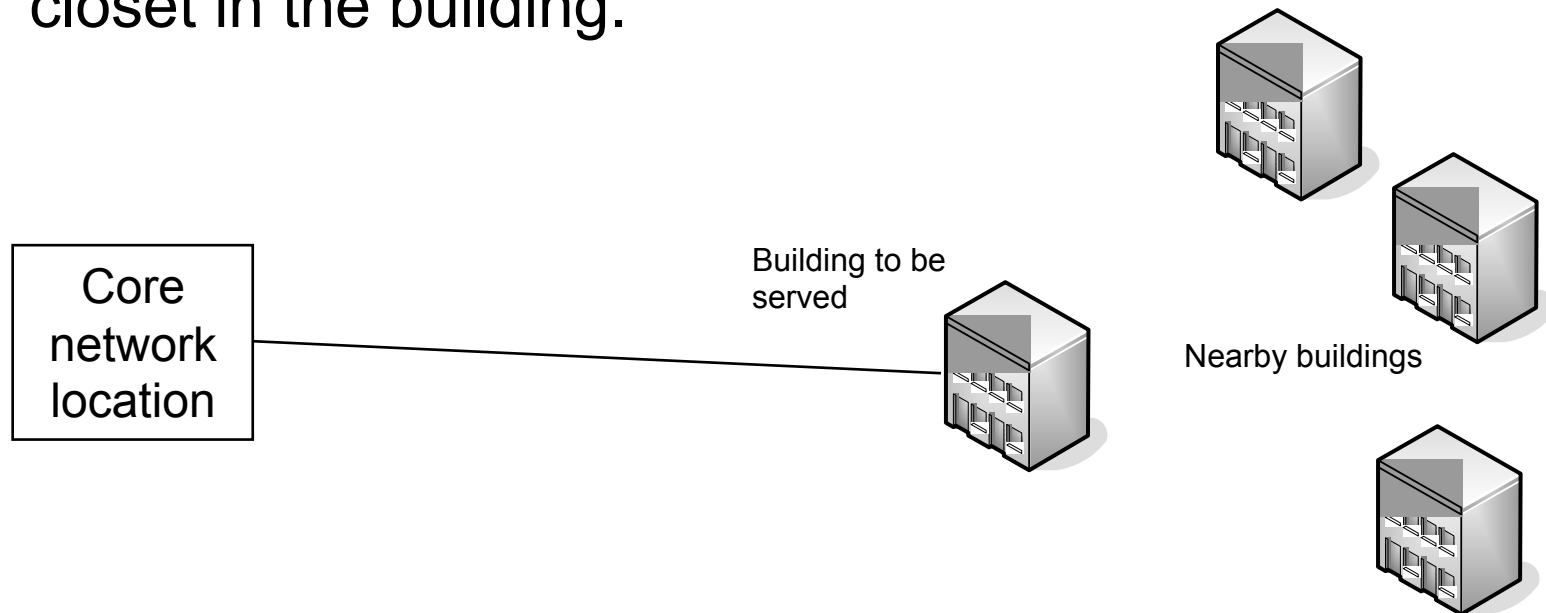

Fiber Optic Topology

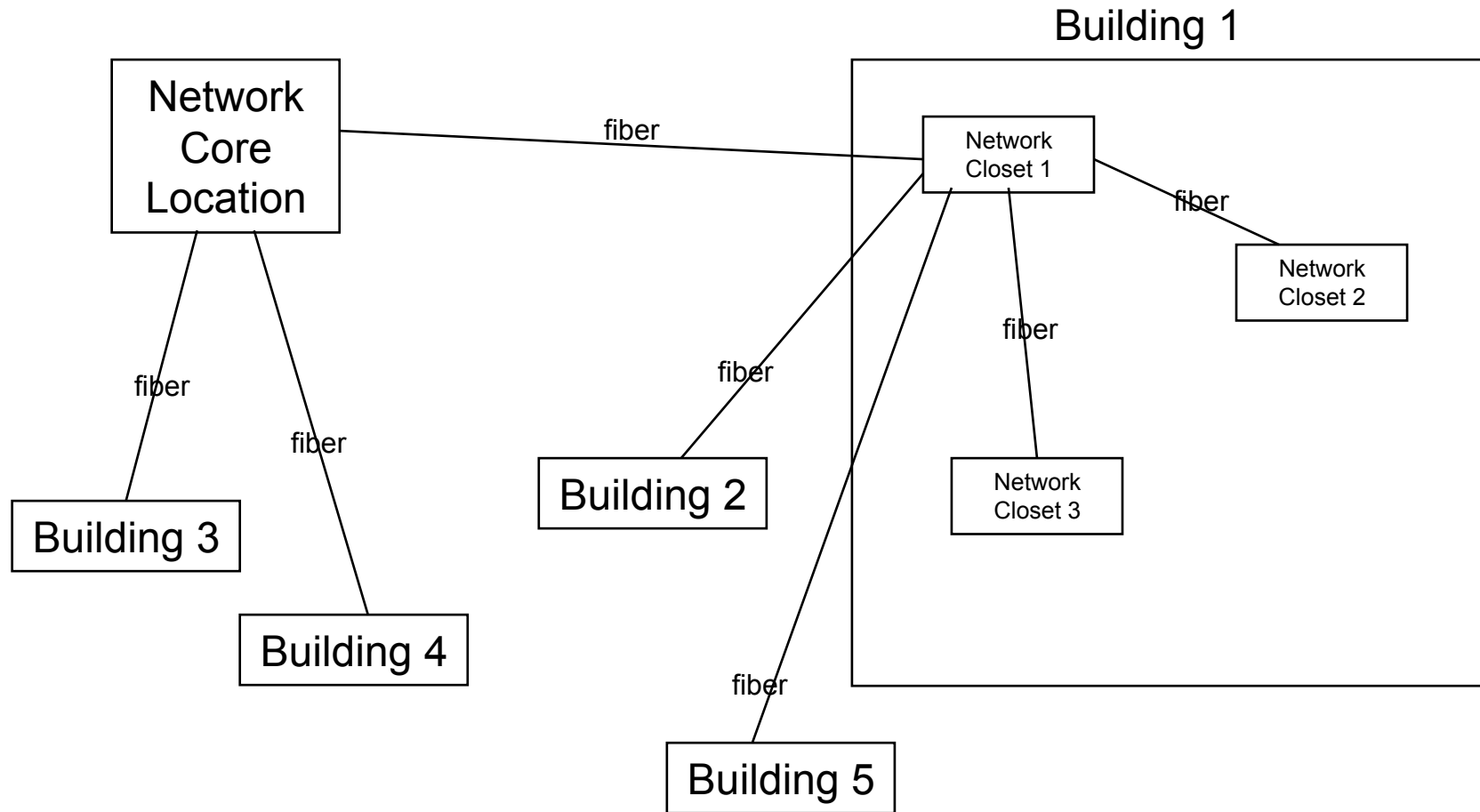

Construction Hints

- Use outdoor cable between buildings
 - Armored (to protect against rodents)
 - Loose tube
- Use indoor cabling inside buildings
 - tight buffer
- Standardize on Connectors
 - Multi mode: ST or SC (epoxy or hot melt)
 - Single mode: SC or LC (fusion Splice factory UPC pigtail)

Fiber Optic Cable Construction

- Fiber has bend radius issues



More Construction Hints

- For cable installed in underground conduit:
 - No more than 200m between pull points
 - Reduce distance by 50m for every 90 degrees of bend

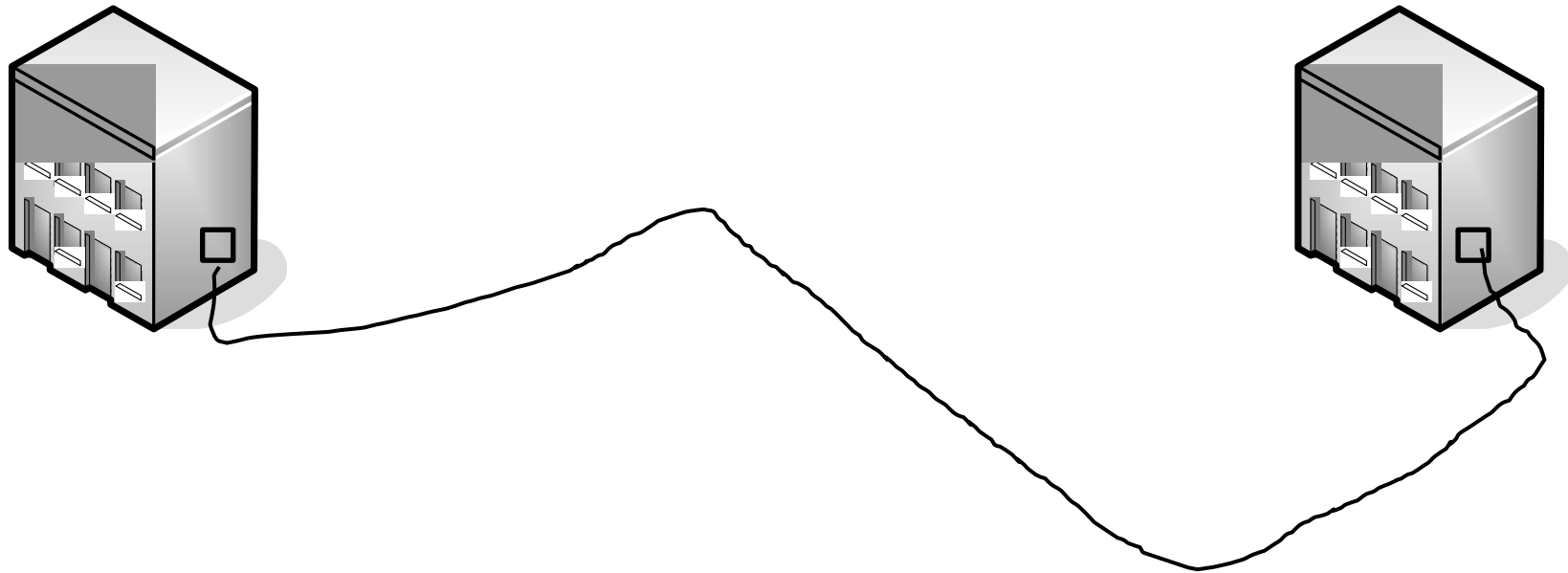

Fiber Optic Cable Construction

- Leave slack loops



Putting it all Together

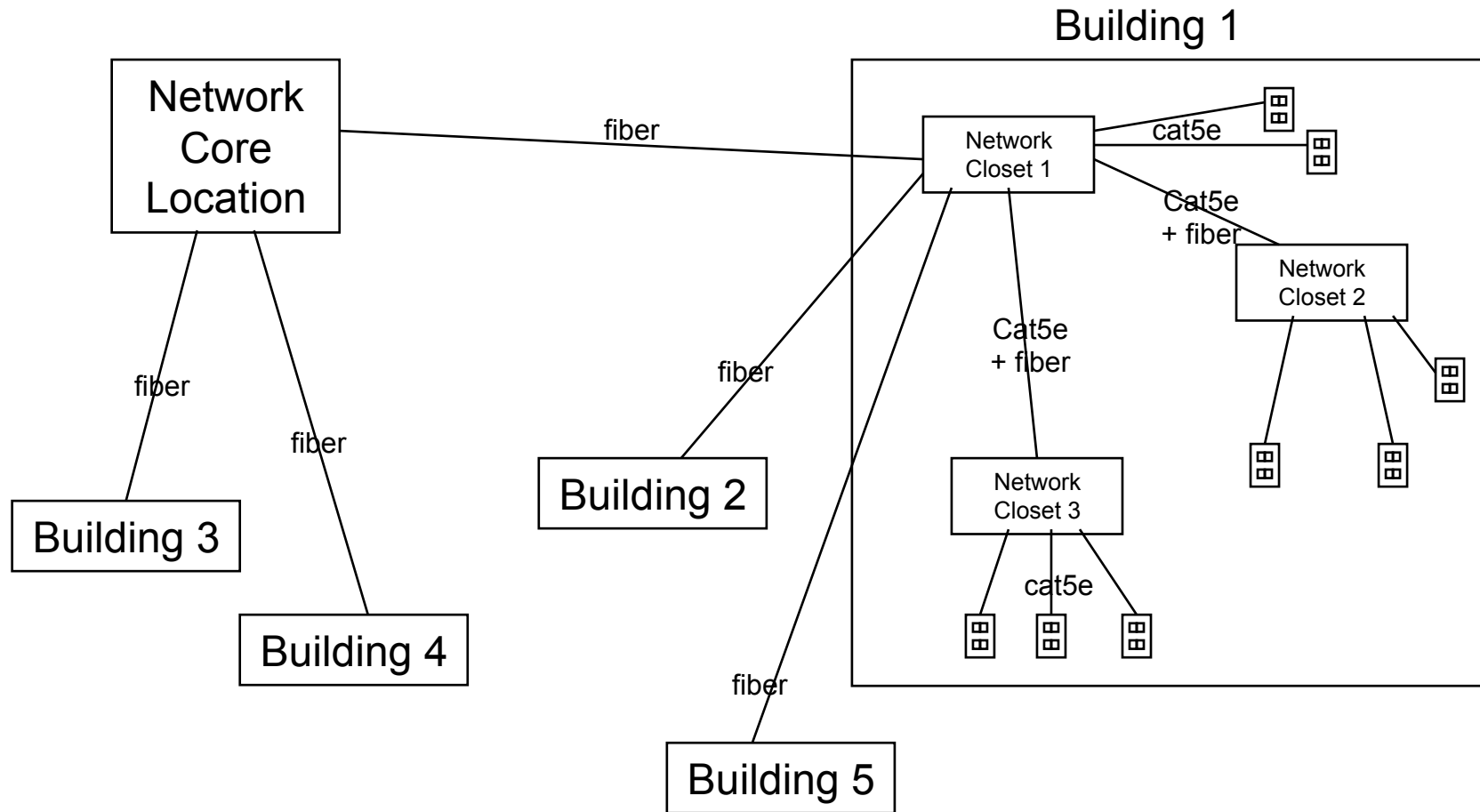

How About Going Even Faster?

- 100 Gigabits?
- Dispersion becomes your enemy
- Even single mode fiber has dispersion
 - Chromatic Dispersion (CD) Even slightly different colors of light travel different speeds
 - Polarization Mode Dispersion (PMD) Slight variations from true roundness causes differently polarized light to travel different distances.

The Solution Today is WDM

- Wave Division Multiplexing (WDM)
 - Provisioning multiple Gigabit or 10 Gigabit using different colors of light
 - Coarse (CWDM)
 - Fewer waves, low cost
 - 1310nm frequency spectrum
 - Not suitable for amplification – short haul (70km)
 - Dense (DWDM) more waves
 - More waves, higher cost
 - 1550nm frequency spectrum
 - Suitable for EDFA amplification – long haul (1000s of km)

WDM Simple Single Span

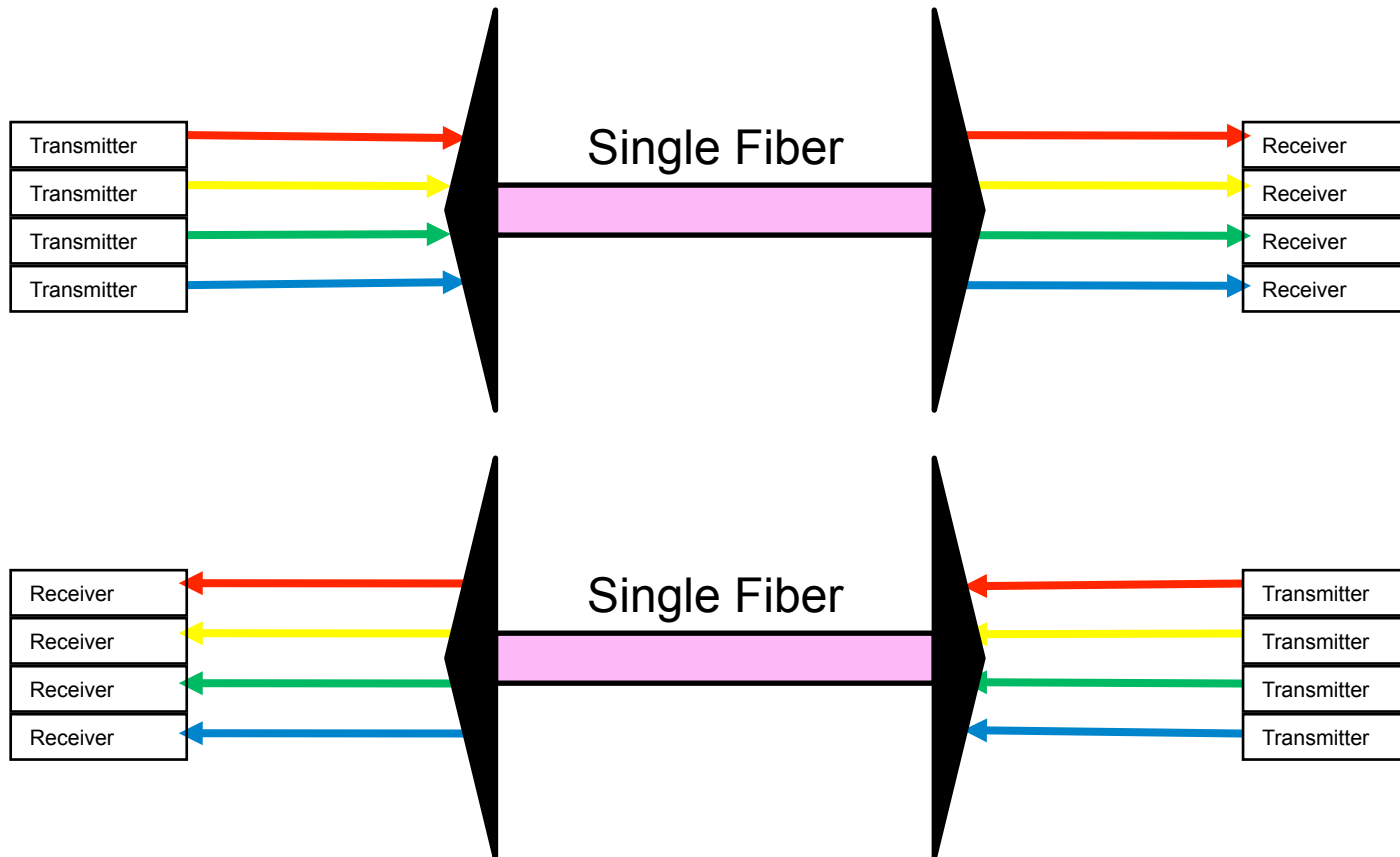

Optical Add Drop Multiplexor

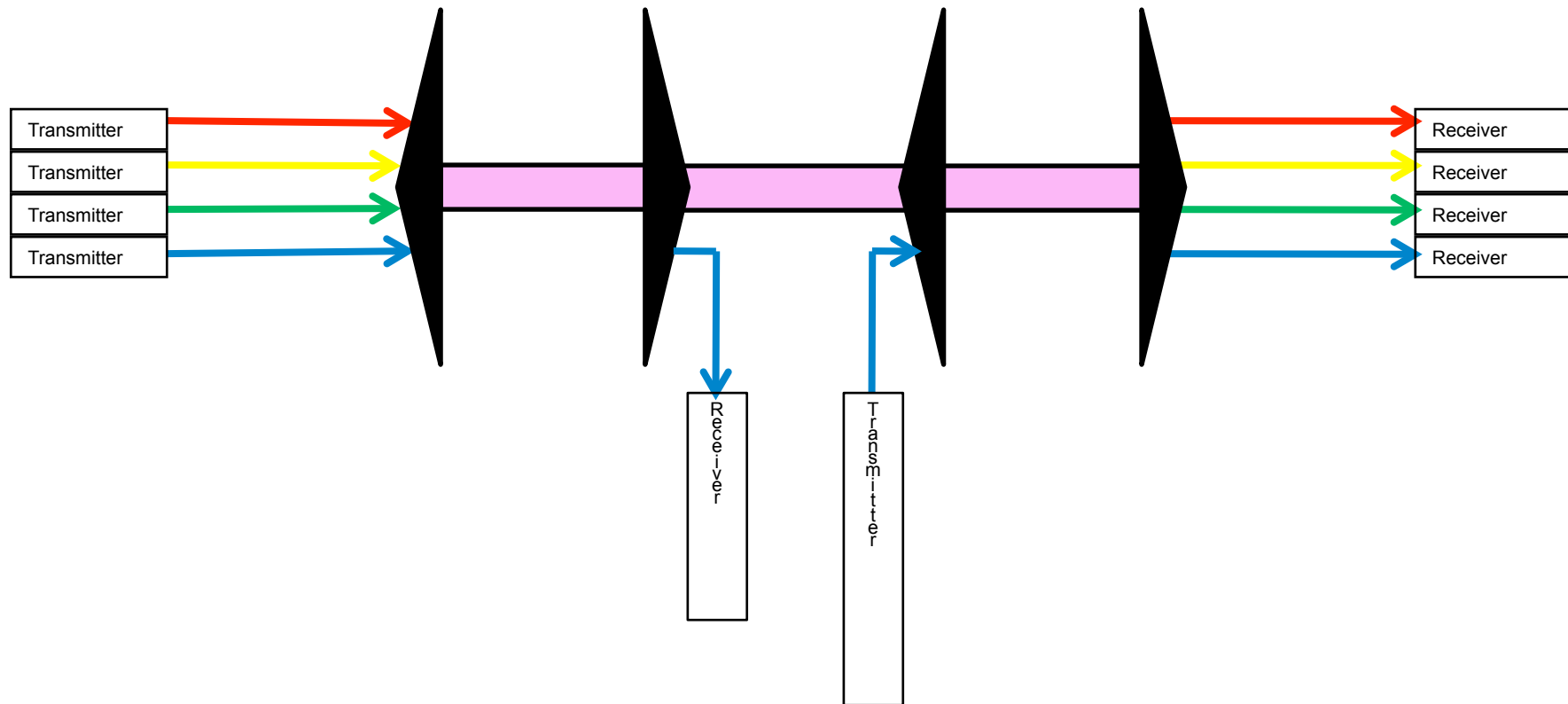

Can Build Complex Networks

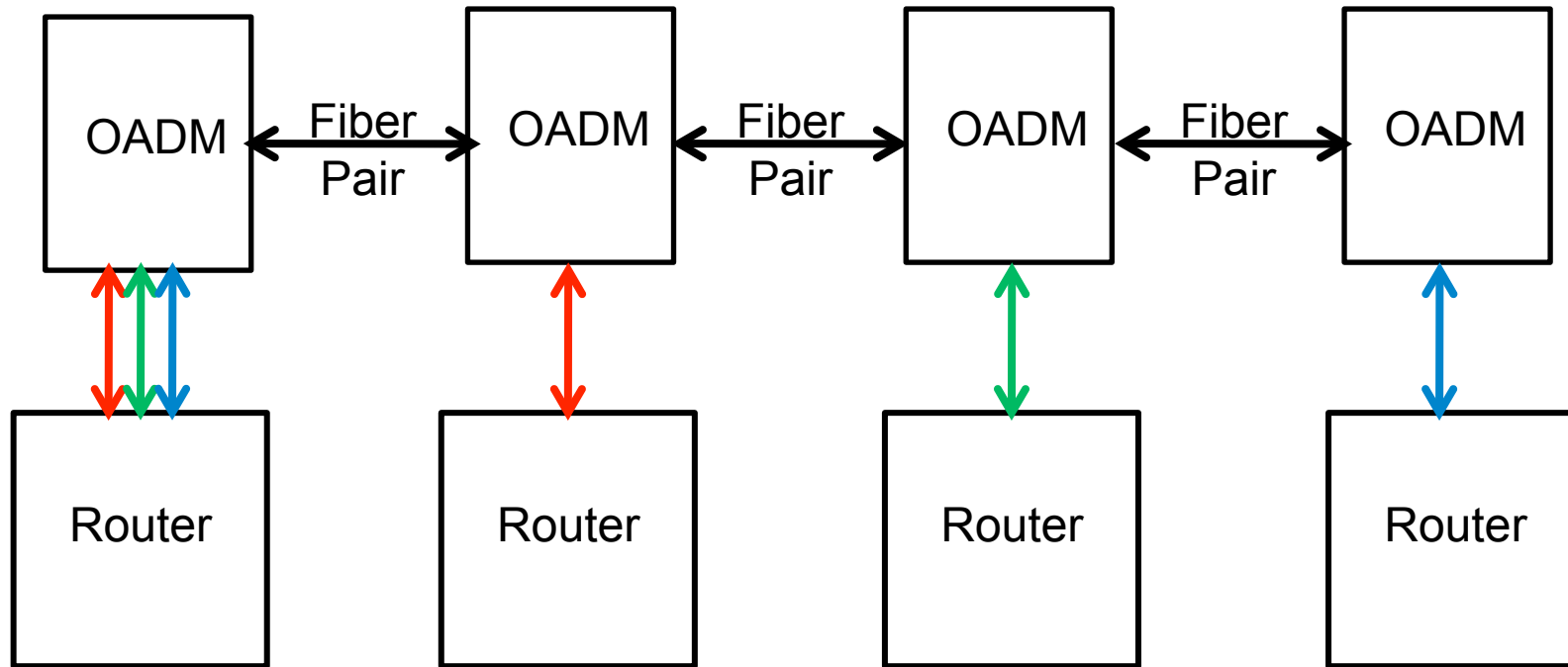

Layer 0 Summary

- Install cabling in star configuration – don't daisy chain
- Install cat5e or cat6a – cat6 is a waste of money if the runs are over 57m
- Install both single and multi mode fiber for runs over 300m

Thank You

Questions