



# MPLS-based Metro Ethernet Networks

## A Tutorial

Paresh Khatri

Jan, 2016

# Agenda

---

- Introduction to Metro Ethernet Services
- Traditional Metro Ethernet networks
- Delivering Ethernet over MPLS
- Summary
- Questions



# 1. Introduction

# Introduction

---

Paresh Khatri (paresh.khatri@alcatel-lucent.com)

- Chief Architect - IP Routing & Transport APAC, Alcatel-Lucent
- Key focus areas:
  - End-to-end network architectures
  - SDN/NFV
  - Large-scale IP/MPLS networks
  - L2/L3 VPNs
  - Carrier Ethernet
  - Next-generation mobile backhaul networks
- Acknowledgements:
  - Some figures and text are provided courtesy of the Metro Ethernet Forum (MEF)



## 2. Introduction to Metro Ethernet Services

# Agenda

---

- 2. Introduction to Metro Ethernet Services
- 2.1 Why Metro Ethernet ?
- 2.2 Attributes of Carrier Ethernet
- 2.3 Carrier Ethernet Services defined by the MEF

---

## 2.1 Why Metro Ethernet ?

# Introduction to Metro Ethernet Services

---

## What is Metro Ethernet ?

- “... generally defined as the network that bridges or connects geographically separated enterprise LANs while also connecting across the WAN or backbone networks that are generally owned by service providers. The Metro Ethernet Networks provide connectivity services across Metro geography utilising Ethernet as the core protocol and enabling broadband applications”

from “Metro Ethernet Networks - A Technical Overview” from the Metro Ethernet Forum



# Introduction to Metro Ethernet Services

---

## Why Metro Ethernet ?

- Benefits both providers and customers in numerous ways ...
- Packet traffic has now overtaken all other traffic types
- Need for rapid provisioning
- Reduced CAPEX/OPEX
- Increased and flexible bandwidth options
- Well-known interfaces and technology

---

## 2.2 Attributes of Carrier Ethernet

# The 5 Attributes of Carrier Ethernet



## Carrier Ethernet

- Carrier Ethernet is a ubiquitous, standardized, carrier-class **SERVICE** defined by five attributes that distinguish Carrier Ethernet from familiar LAN based Ethernet
- It brings the compelling business benefit of the Ethernet cost model to achieve significant savings

## Carrier Ethernet Attributes

- **Standardized Services**
- **Scalability**
- **Service Management**
- **Reliability**
- **Quality of Service**

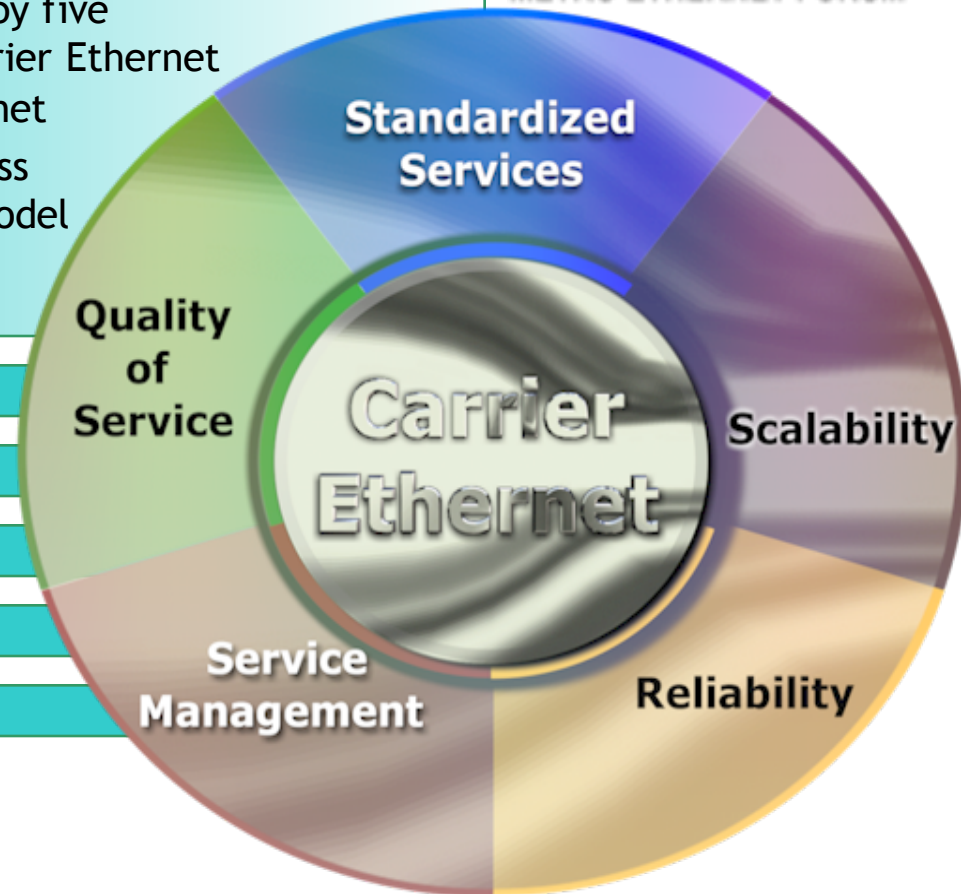

---

## 2.3 Carrier Ethernet Services defined by the MEF

# Introduction to Metro Ethernet Services

---

What do we mean by Metro Ethernet services ?

- Use of Ethernet access tails
- Provision of Ethernet-based services across the MAN/WAN
  - Point-to-point
  - Point-to-multipoint
  - Multipoint-to-multipoint
- However, the underlying infrastructure used to deliver Ethernet services does NOT have to be Ethernet !!!
- Referred to as Carrier Ethernet services by the Metro Ethernet Forum
  - The terms “Carrier Ethernet” and “Metro Ethernet” are used interchangeably in this presentation, but in the strict sense of the term, “Carrier Ethernet” refers to the carrier-grade evolution of “Metro Ethernet”

# MEF Carrier Ethernet Terminology

## The User Network Interface (UNI)

- The UNI is the physical interface or port that is the demarcation between the customer and the service provider/Cable Operator/Carrier/MSO
- The UNI is always provided by the Service Provider
- The UNI in a Carrier Ethernet Network is a standard physical Ethernet Interface at operating speeds 10Mbps, 100Mbps, 1Gbps or 10Gbps

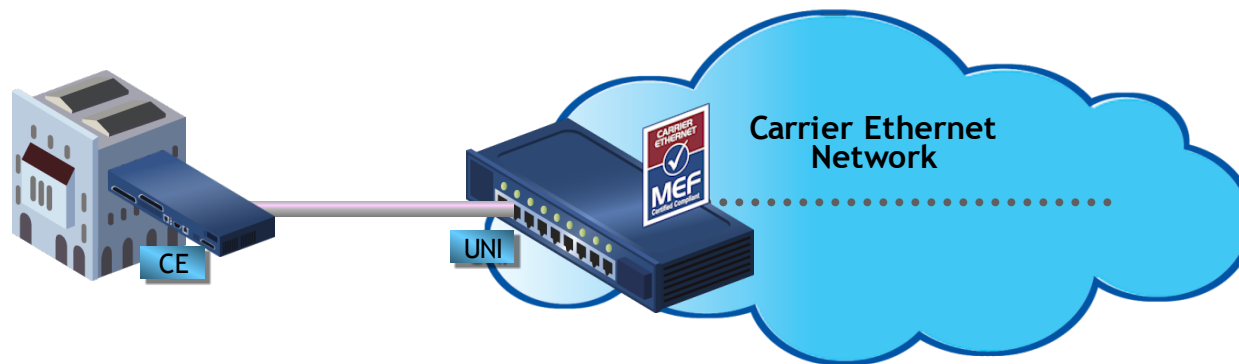

CE: Customer Equipment, UNI: User Network Interface.



MEF certified Carrier Ethernet products

# MEF Carrier Ethernet Terminology

## The User Network Interface (UNI):

- MEF has defined two types of UNIs:
  - MEF UNI Type I (MEF 13)
    - A UNI compliant with MEF 13
    - Manually configurable
    - Specified for existing Ethernet devices
    - Provides bare minimum data-plane connectivity services with no control-plane or management-plane capabilities.
  - MEF UNI Type II (MEF 20)
    - Automatically configurable via E-LMI (allowing UNI-C to retrieve EVC status and configuration information from UNI-N)
    - Manageable via OAM

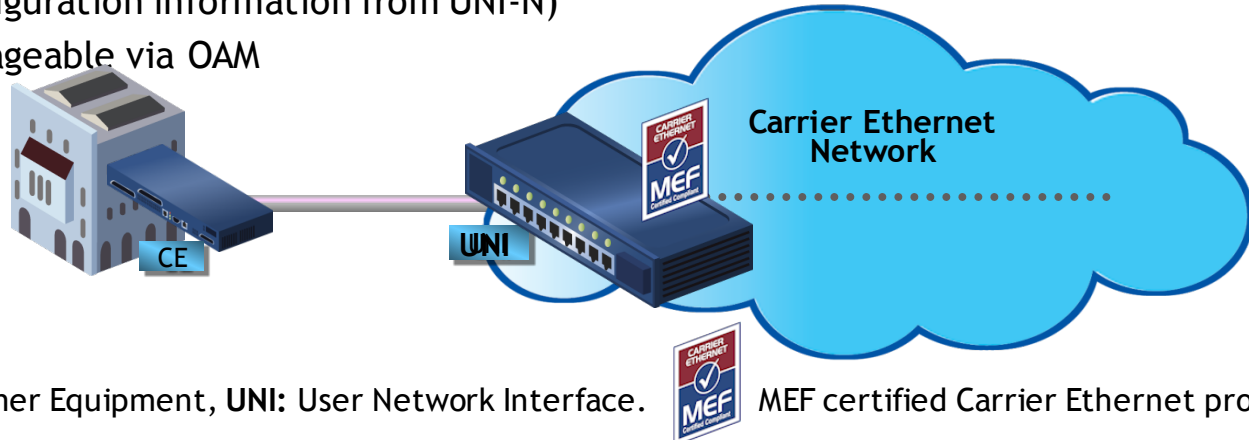

CE: Customer Equipment, UNI: User Network Interface.

MEF certified Carrier Ethernet products

# MEF Carrier Ethernet Terminology

- Customer Equipment (CE) attaches to the Metro Ethernet Network (MEN) at the UNI
  - Using standard Ethernet frames.
- CE can be
  - Router or bridge/switch - IEEE 802.1 bridge

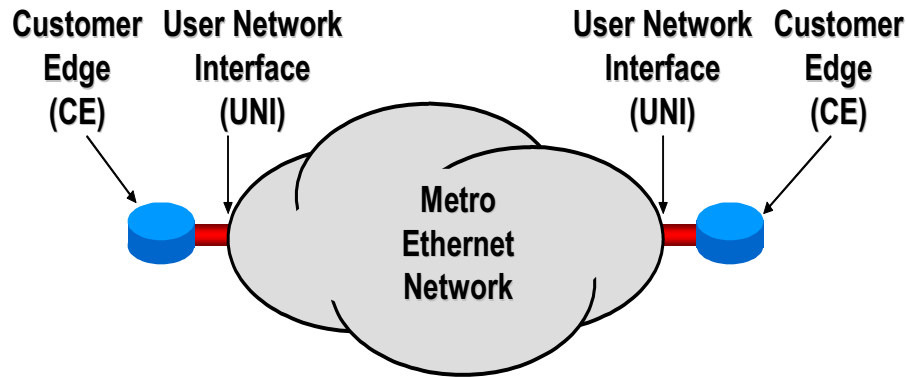



# MEF Ethernet Services Model

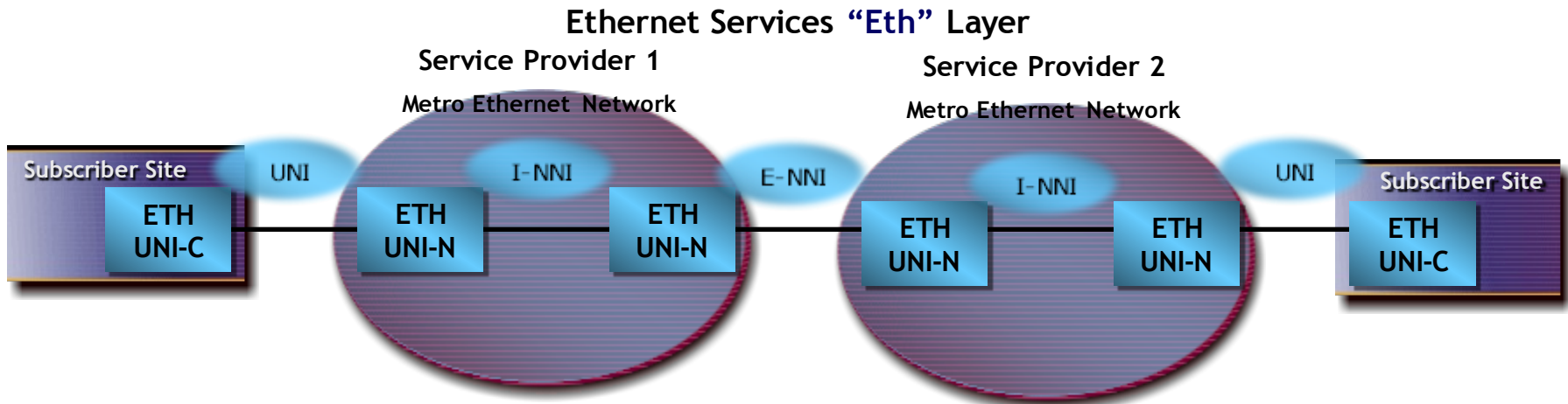

**UNI: User Network Interface, UNI-C: UNI-customer side, UNI-N network side  
NNI: Network to Network Interface, E-NNI: External NNI; I-NNI Internal NNI**

# MEF Carrier Ethernet Terminology

---

## Ethernet Virtual Connection (EVC)

- An Ethernet Service Instantiation
  - Most commonly (but not necessarily) identified via a VLAN-ID
  - Like Frame Relay and ATM PVCs or SVCs
- Connects two or more subscriber sites (UNI's)
  - Can multiplex multiple EVCs on the same UNI
- An association of two or more UNIs
- Prevents data transfer between sites that are not part of the same EVC

# MEF Carrier Ethernet Terminology

## Ethernet Virtual Connection (EVC)

- Three types of EVC:

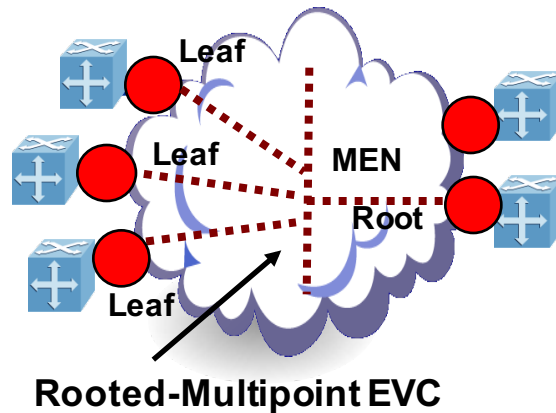
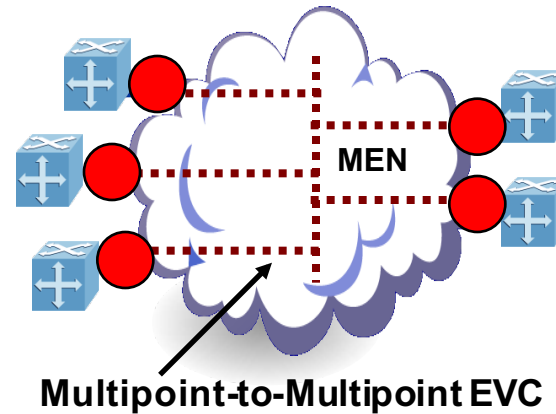

# Basic Carrier Ethernet Services

E-LINE



Point to Point  
Service Type used to create

- Ethernet Private Lines
- Virtual Private Lines
- Ethernet Internet Access

E-LAN

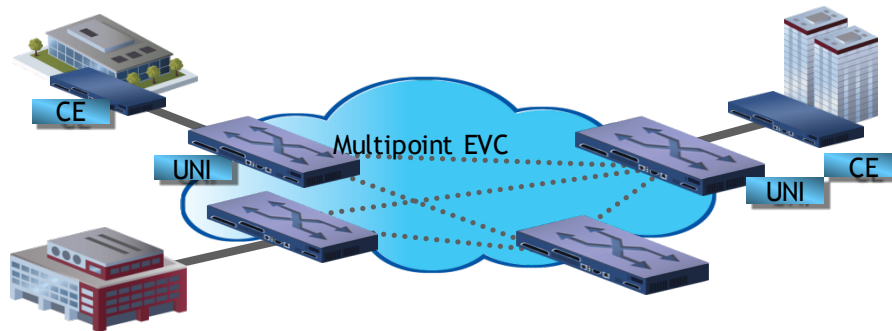

Multi-Point to Multi-Point  
Service Type used to create

- Multipoint Layer 2 VPNs
- Transparent LAN Service

E-TREE

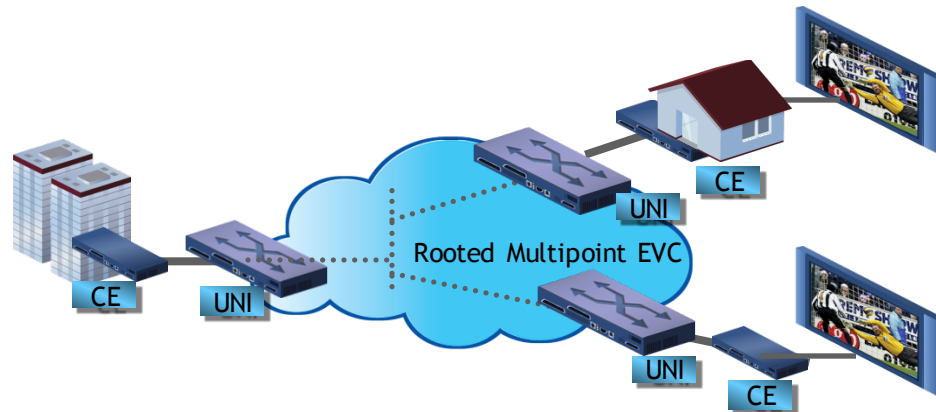

Point to Multi-Point

- Efficient use of Service Provider ports
- Foundation for Multicast networks e.g. IPTV

# EVCs and Services

In a Carrier Ethernet network, data is transported across Point-to-Point, Multipoint-to-Multipoint and Point-to-Multipoint EVCs according to the attributes and definitions of the E-Line, E-LAN and E-Tree services respectively.

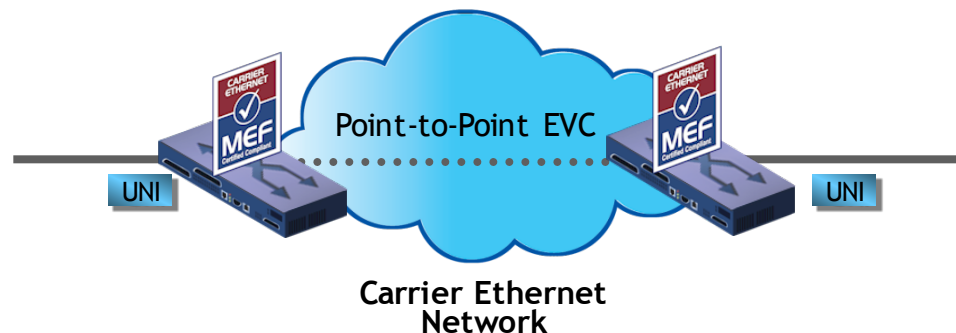

# Services Using E-Line Service Type

## Ethernet Private Line (EPL)

- Replaces a TDM Private line
- Dedicated UNIs for Point-to-Point connections
- Single Ethernet Virtual Connection (EVC) per UNI

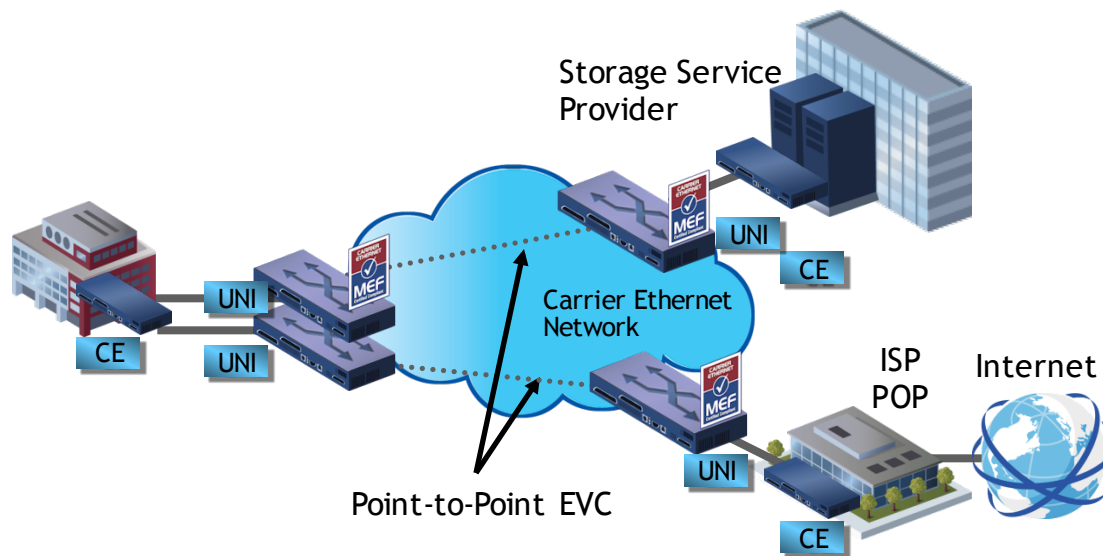

# Services Using E-Line Service Type

## Ethernet Virtual Private Line (EVPL)

- Replaces Frame Relay or ATM services
- Supports Service Multiplexed UNI (i.e. multiple EVCs per UNI)
- Allows single physical connection (UNI) to customer premise equipment for multiple virtual connections
- This is a UNI that must be configurable to support Multiple EVCs per UNI

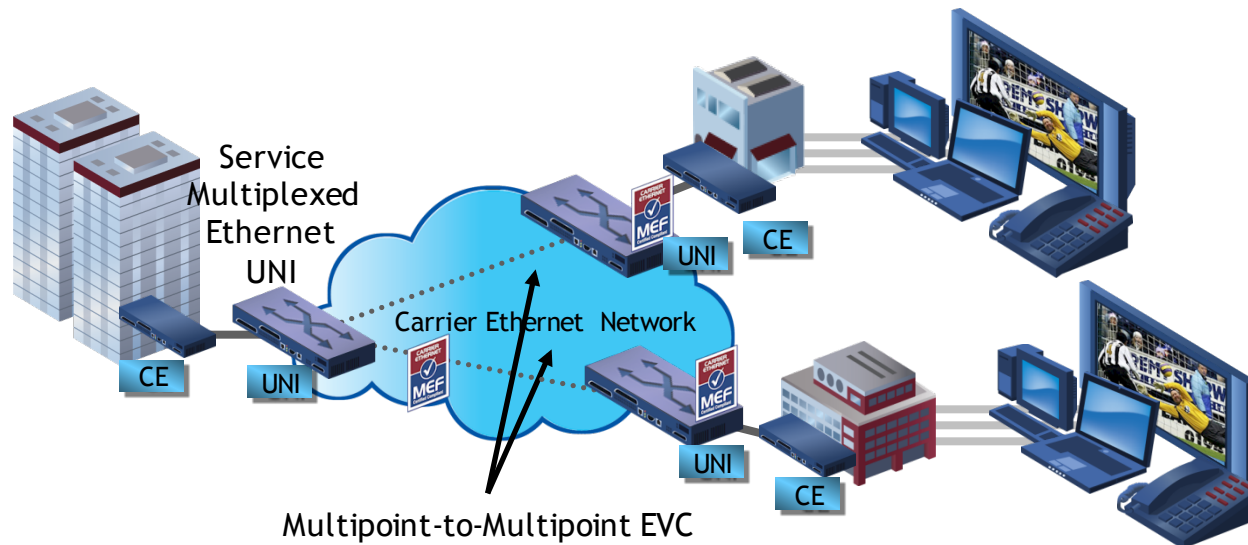

# Services Using E-LAN Service Type

## Ethernet Private LAN and Ethernet Virtual Private LAN Services

- Supports dedicated or service-multiplexed UNIs
- Supports transparent LAN services and multipoint VPNs

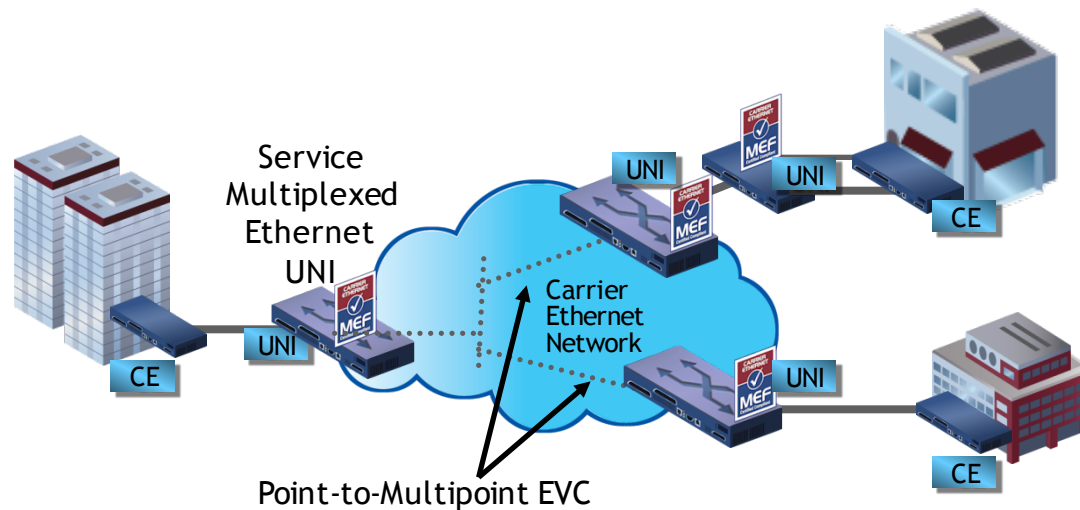



# Services Using E-Tree Service Type

## Ethernet Private Tree (EP-Tree) and Ethernet Virtual Private Tree (EVP-Tree) Services

- Enables Point-to-Multipoint Services with less provisioning than typical hub and spoke configuration using E-Lines
- Provides traffic separation between users with traffic from one “leaf” being allowed to arrive at one of more “roots” but never being transmitted to other “leaves”

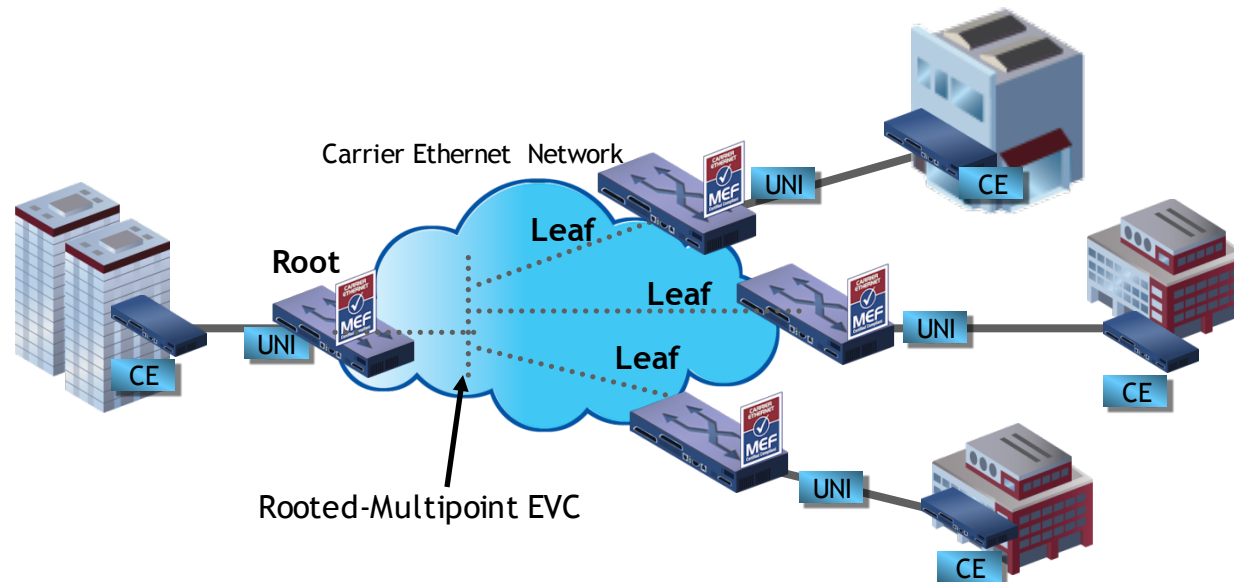

Ethernet Private Tree example

## Audience Question 1

---

**Name any two of the five attributes of Carrier Ethernet as defined by the Metro Ethernet Forum.**





### 3. Traditional Metro Ethernet networks

# Agenda

---

- 3. Traditional Metro Ethernet Networks
  - 3.1 Service Identification
  - 3.2 Forwarding Mechanism
  - 3.3 Resiliency and Redundancy
  - 3.4 Recent Developments
  - 3.5 Summary

# Traditional Metro Ethernet Networks

## Traditional methods of Ethernet delivery:

- Ethernet switching/bridging networks (802.1d/802.1q)
  - Services identified by VLAN IDs/physical ports
  - VLAN IDs globally significant
  - Resiliency provided using variants of the Spanning Tree Protocol

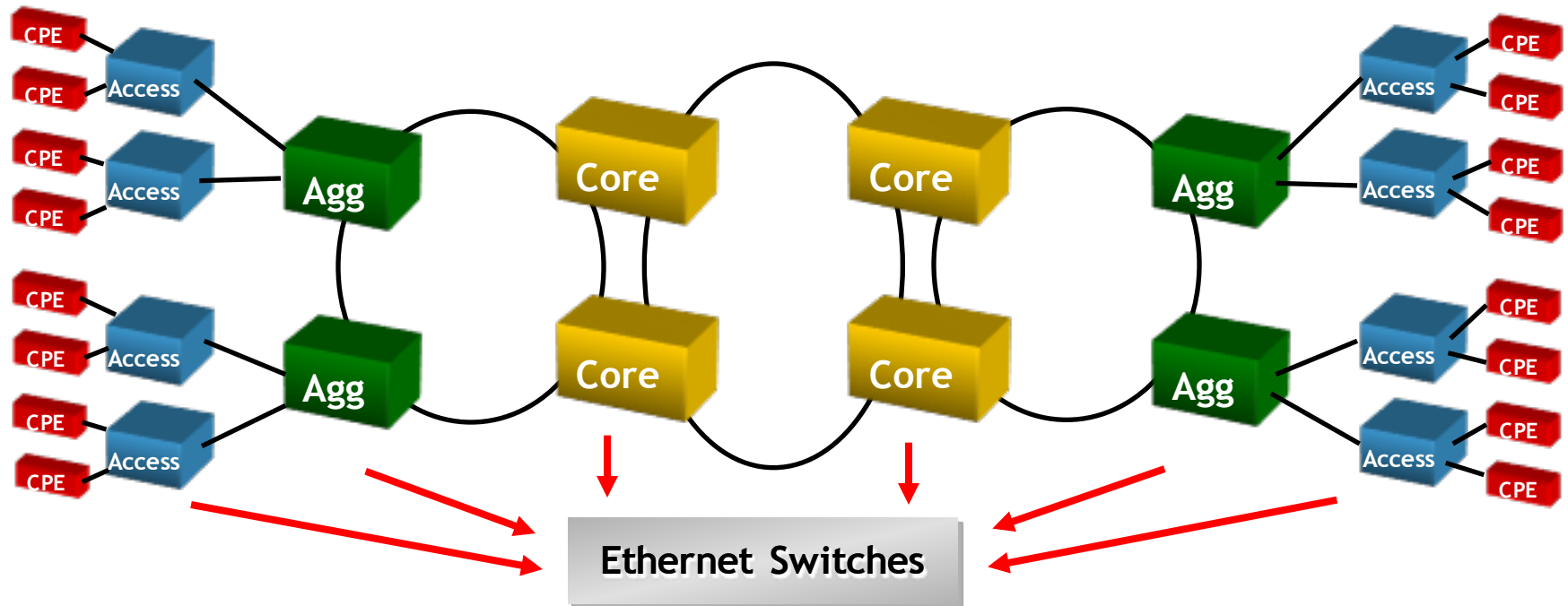

---

## 3.1 Service Identification

# Traditional Metro Ethernet Networks

## Service Identification:

- Ethernet switching/bridging networks
- First generation was based on IEEE 802.1q switches
  - One obvious limitation was the VLAN ID space - the 12-bit VLAN ID allows a maximum of 4094 VLANs (VLANs 0 and 4095 are reserved). This limited the total number of services in any one switching/bridging domain.
  - The other problem was that of customer VLAN usage - customers could not carry tagged traffic transparently across the network

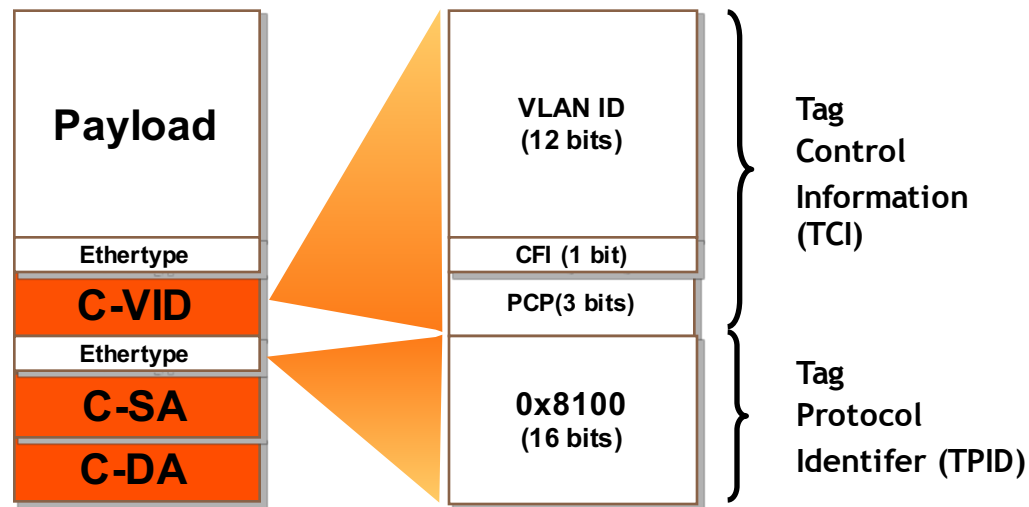

# Traditional Metro Ethernet Networks

## Service Identification :

- Q-in-Q (aka VLAN stacking, aka 802.1ad) comes to the rescue !
  - Q-in-Q technology, which has now been standardised by the IEEE as 802.1ad (Provider Bridging), allowed the addition of an additional tag to customer Ethernet frames - the S-tag. The S-tag (Service Tag) was imposed by the Service Provider and therefore, it became possible to carry customer tags (C-tags) transparently through the network.

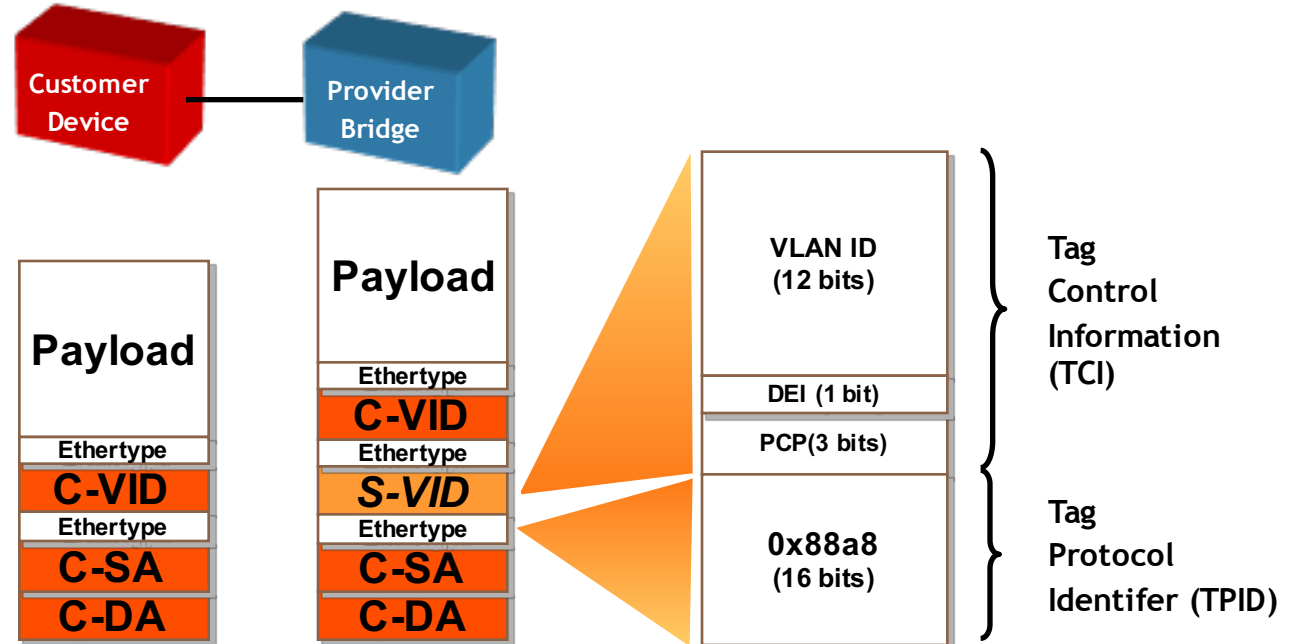



# Traditional Metro Ethernet Networks

---

## Service Identification:

- Some important observations about Q-in-Q:
  - This is not a new encapsulation format; it simply results in the addition of a second tag to the customer Ethernet frame, allowing any customer VLAN tags to be preserved across the network
  - There is no change to the customer destination or source MAC addresses
  - The number of distinct service instances within each Provider Bridging domain is still limited by the S-VLAN ID space i.e. 4094 S-VLANs. The difference is that customer VLANs can now be preserved and carried transparently across the provider network.

---

# 3.2 Forwarding Mechanism

# Traditional Metro Ethernet Networks

## Forwarding Mechanism:

- Dynamic learning methods used to build forwarding databases

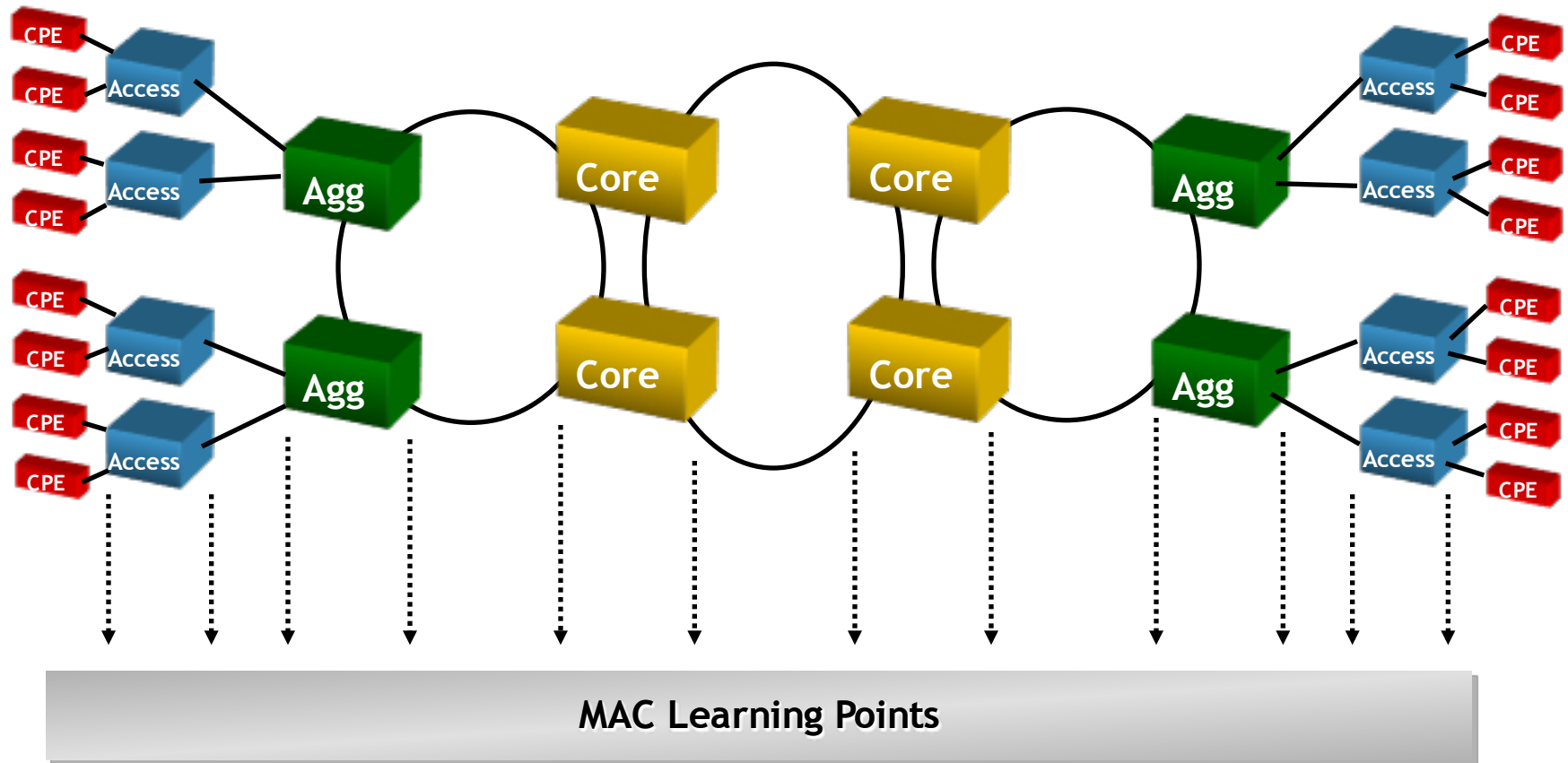

MAC Learning Points

# Traditional Metro Ethernet Networks

## Forwarding Mechanism:

- Dynamic learning methods used to build forwarding databases

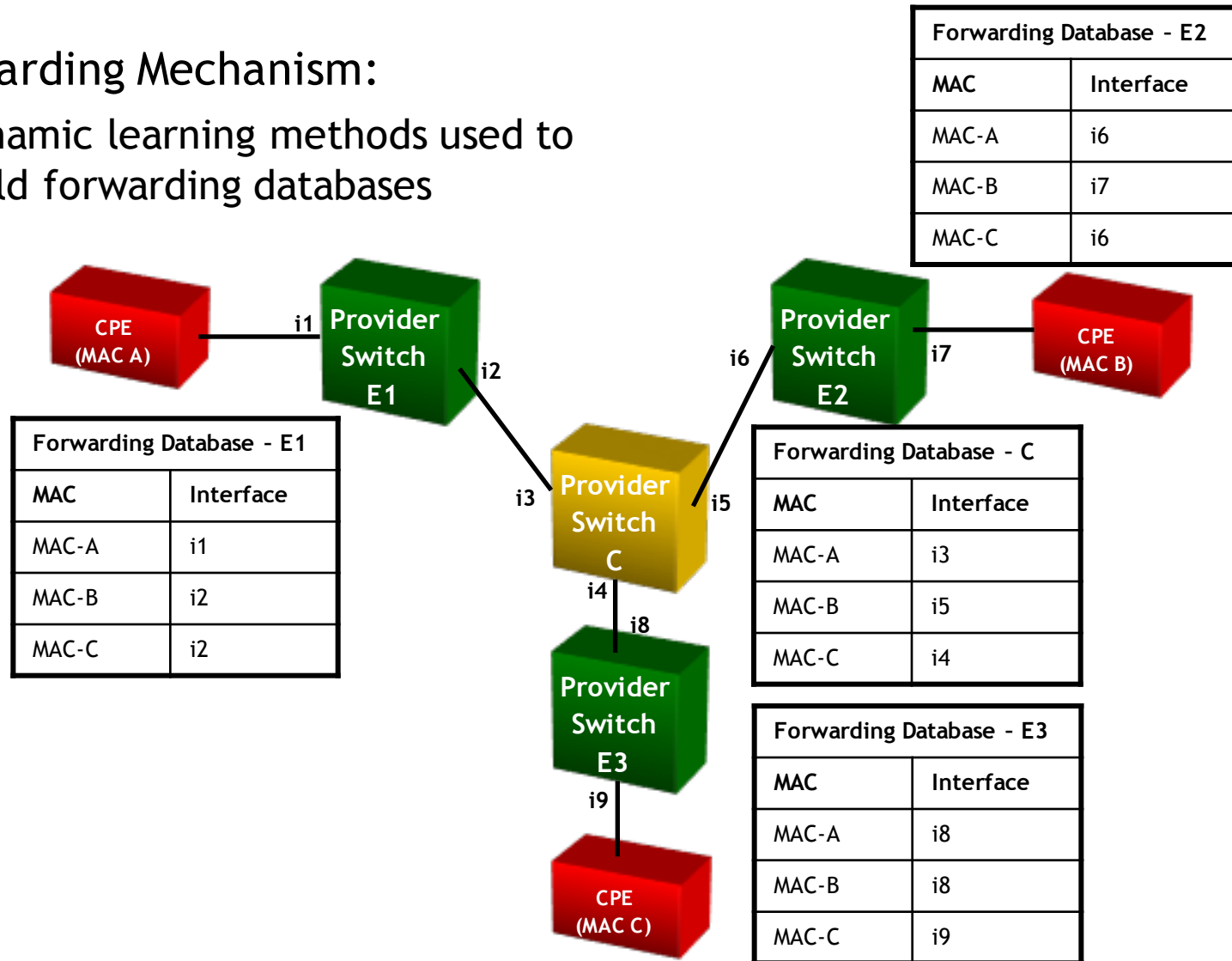

# Traditional Metro Ethernet Networks

---

## Forwarding Mechanism:

- Dynamic learning methods used to build forwarding databases
  - Data-plane process - there are no control-plane processes for discovering endpoint information
- In the worst case, ALL switches have forwarding databases that include ALL MAC addresses. This is true even for switches in the core of the network (Switch C in preceding example).
  - Switches have limited resources for storing MAC addresses. This poses severe scaling issues in all parts of the network. VLAN-stacking does not help with this problem.
  - On topology changes, forwarding databases are flushed and addresses need to be re-learned. While these addresses are re-learned, traffic to unknown destinations is flooded through the network, resulting in wasted bandwidth.

---

# 3.3 Resiliency and Redundancy

# Traditional Metro Ethernet Networks

---

## Resiliency and Redundancy

- Redundancy is needed in any network offering Carrier-grade Ethernet BUT loops are bad !!
- The Spanning Tree Protocol (STP) is used to break loops in bridged Ethernet networks
  - There have been many generations of the STP over the years
  - All of these variants work by removing redundant links so that there is one, and only one, active path from each switch to every other switch i.e. all loops are eliminated. In effect, a minimum cost tree is created by the election of a root bridge and the subsequent determination of shortest-path links to the root bridge from every other bridge
  - Bridges transmit special frames called Bridge Protocol Data Units (BPDUs) to exchange information about bridge priority, path costs etc.
- High Availability is difficult to achieve in traditional Metro Ethernet networks.

# Traditional Metro Ethernet Networks

## Building the Spanning Tree ...

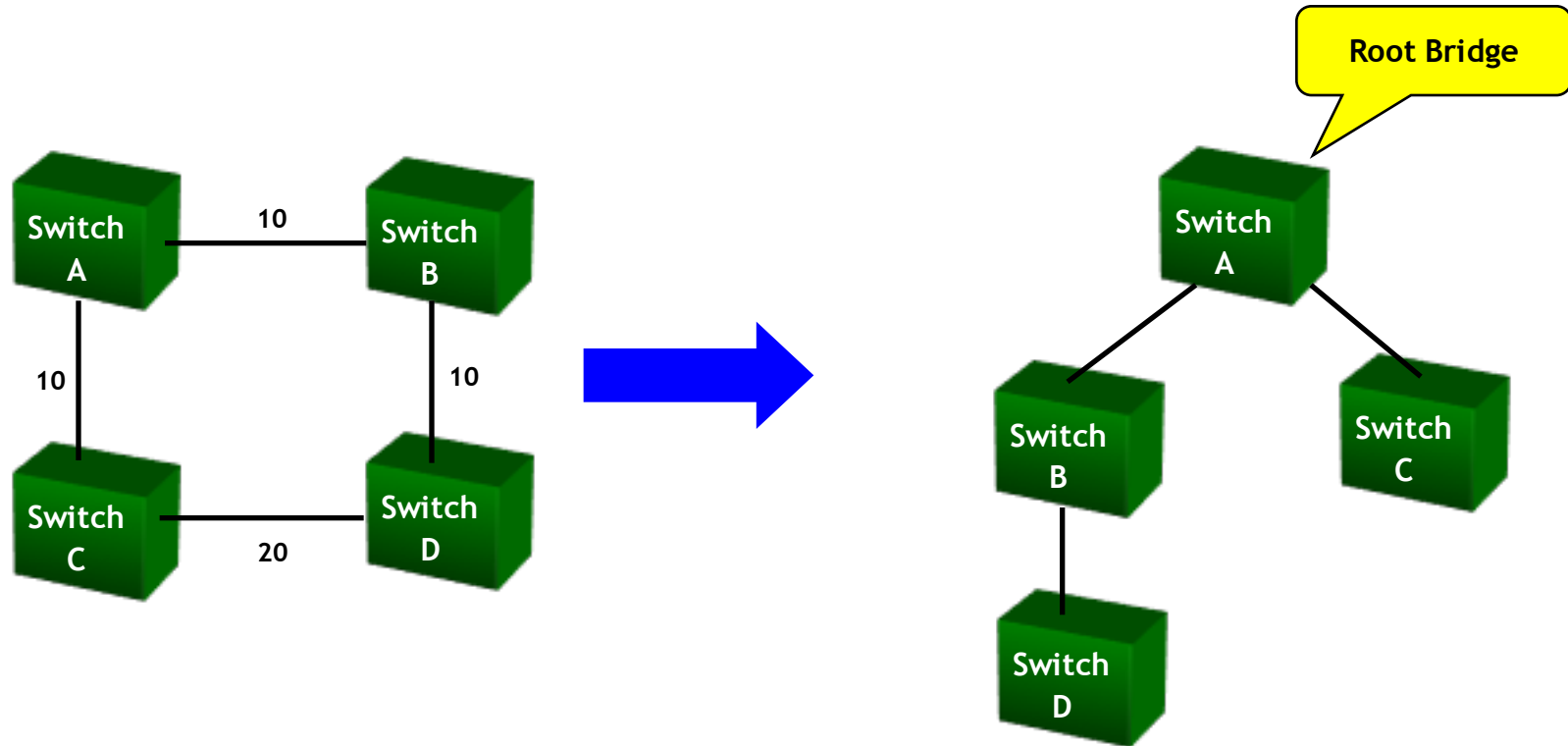

Rudimentary Traffic-Engineering Capabilities



# Traditional Metro Ethernet Networks

---

## First generation of STP (IEEE802.1d-1998):

- Had a number of significant shortcomings:
  - Convergence times - the protocol is timer-based with times in the order of 10s of seconds. After network topology changes (failure or addition of links), it could take up to 50s for the network to re-converge
  - The protocol was VLAN-unaware, which meant that in an IEEE 802.1q network, all VLANs had to share the same spanning tree. This meant that there were network links that would not be utilised at all since they were placed into a blocked state.
    - Many vendors implemented their own, proprietary extensions to the protocol to allow the use of a separate STP instance per VLAN, allowing better link utilisation within the network
  - There were many conditions which resulted in the inadvertent formation of loops in the network. Given the flooding nature of bridged Ethernet, and the lack of a TTL-like field in Ethernet frames, looping frames could loop forever.
    - There are numerous well-publicised instances of network meltdowns in Enterprise and Service Provider networks
    - A lot of service providers have been permanently scarred by the catastrophic effects of STP loops !

# Traditional Metro Ethernet Networks

---

Newer generations of STP (IEEE802.1d-2004 - Rapid STP aka 802.1w):

- Some major improvements:
  - Dependence on timers is reduced. Negotiation protocols have been introduced to allow rapid transitioning of links to a forwarding state
  - The Topology Change process has been re-designed to allow faster recovery from topology changes
  - Optimisations for certain types of direct and indirect link failures
  - Convergence times are now down to sub-second in certain special cases but a lot of failure cases still require seconds to converge !
- But...
  - The protocol was still VLAN-unaware, which meant that the issue of under-utilised links was still present

# Traditional Metro Ethernet Networks

---

Newer generations of STP (IEEE802.1q-2003 - Multiple STP aka 802.1s):

- Built on top of RSTP
- Added VLAN awareness:
  - Introduces the capability for the existence of multiple STP instances within the same bridged network
  - Allows the association of VLANs to STP instances, in order to provide a (relatively) small number of STP instances, instead of using an instance per VLAN.
  - Different STP instances can have different topologies, which allows much better link utilisation
- BUT
  - The stigma associated with past failures is hard to remove...
  - The protocol is fairly complicated, compared to its much simpler predecessors

---

# 3.4 Recent Developments

# Recent Developments

---

## Provider Backbone Bridging

- Takes IEEE 802.1ad to the next level
- MAC-in-MAC technology:
  - Customer Ethernet frames are encapsulated in a provider Ethernet frame
- Alleviates the MAC explosion problem
  - Core switches no longer need to learn customer MAC addresses
- Does not address the STP issue, however.



# Provider Backbone Bridging (PBB)

Ethernet Technology being standardized in IEEE 802.1ah Task Group

- Designed to interconnect Provider Bridge Networks (PBN - IEEE 802.1ad)
- Adds a Backbone Header to a Customer/QinQ Ethernet Frame
  - Provider Addressing for Backbone Forwarding
  - New extended tag for Service Virtualization
- Standardization ongoing

**BEB:**  
Backbone Edge Bridge

Forward frames based on backbone MAC addresses

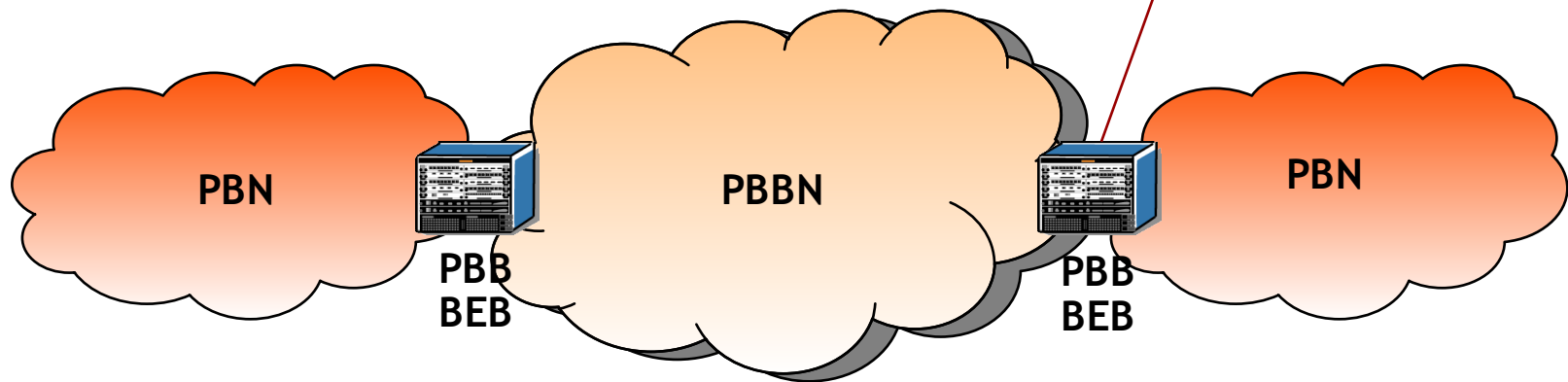

**PBBN is Ethernet based:  
Connectionless Forwarding based on MAC Learning & Forwarding,  
Loop Avoidance based on STP,  
VLAN ID for Broadcast Containment**

# IEEE 802.1ah Model for PBB - I and B Components

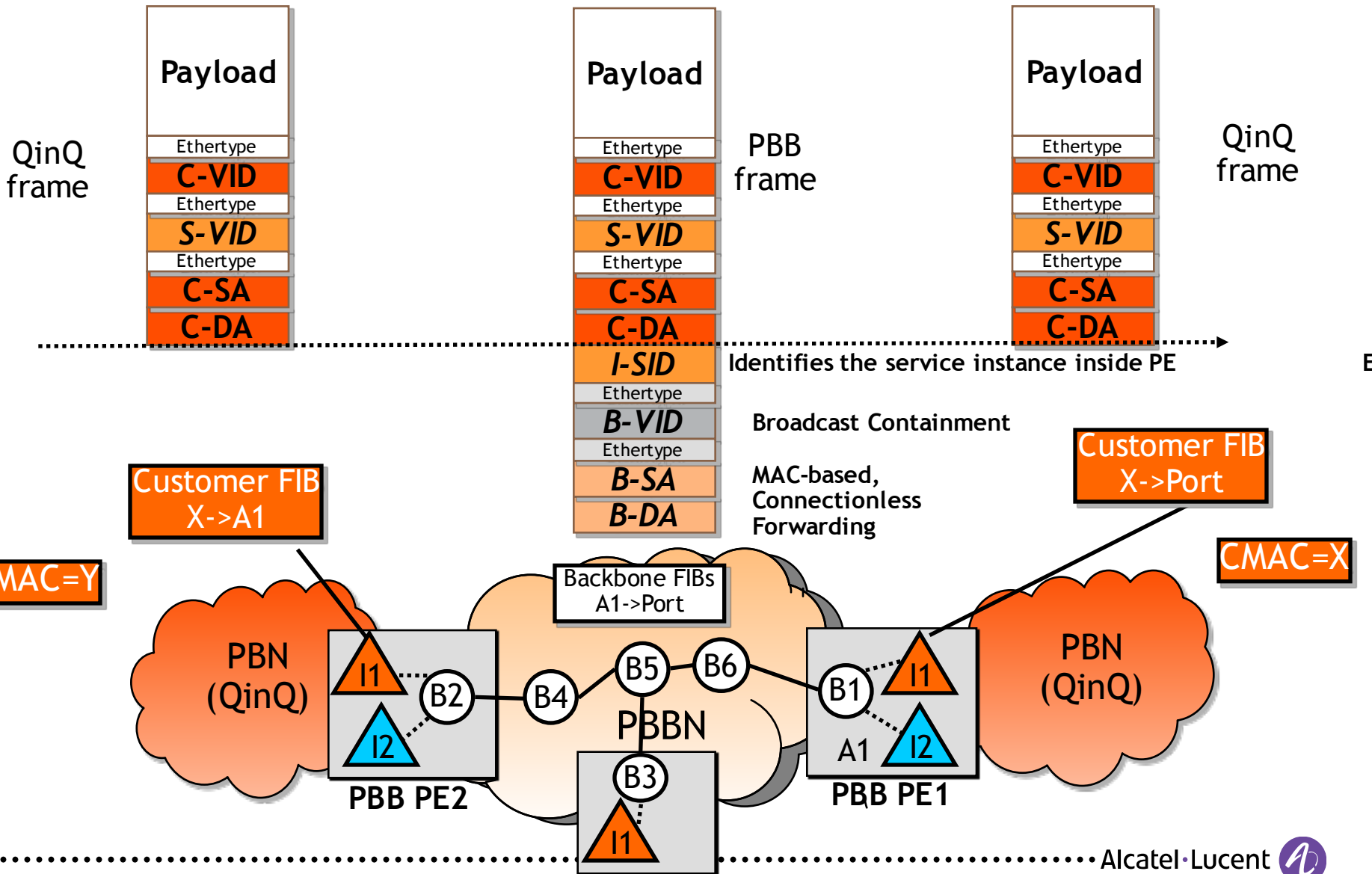

# 802.1ah Provider Backbone Bridge Encapsulation

I-PCP = Customer Priority

I-DEI = Drop Eligibility

UCA = Use Customer Addresses

I-SID = Service Instance ID

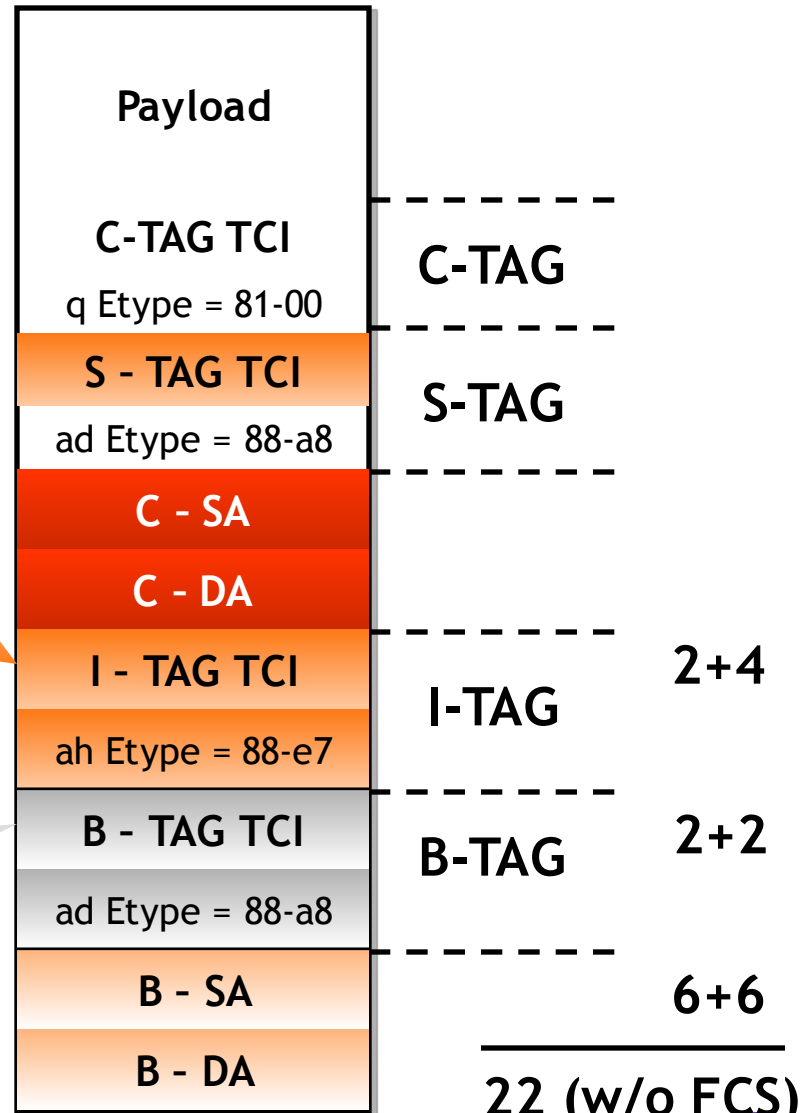
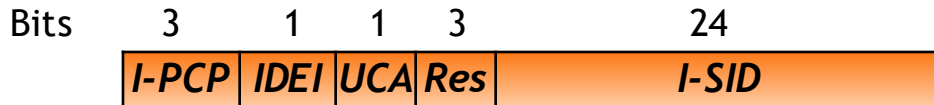

22 (w/o FCS)



# Recent Developments

---

## Shortest Path Bridging

- Addresses the STP issue...
- SPBM is a Spanning-Tree Protocol replacement for PBB
- Being standardized in the IEEE in 802.1aq
  - Shortest path backbone bridging Mac/VLAN Mode
- Requirements to address:
  - No blocked ports like STP
  - Fast resiliency
  - No hop count restrictions like STP
  - Simple networking paradigm

# Shortest Path Bridging

---

## How it works:

- Discover the network topology
  - Enable a routing protocol on each system to discover the network topology
- Build shortest path trees between the network nodes
  - To be used later for forwarding traffic on
- Distribute the service information to the network nodes
  - Once services are created (i.e. ISIDs), the routing protocol is used to distribute the information to all SPBM nodes
  - All nodes (edge and core) are now aware of all VPNs *and* where the endpoints are.
- Update Forwarding Tables to connect the service nodes
  - If the node determines that it is on the shortest path between endpoints for an ISID, it updates its FIB for forwarding.
  - When all nodes on shortest path complete the calculations, the VPN is connected!

# Shortest Path Bridging - Operation

1. Discover network topology
  - [IS-IS](#) enabled on nodes,
  - Each node/link is automatically discovered
2. Nodes use IS-IS link state to automatically build trees from itself to all nodes:

## Important properties:

- Shortest path tree based on link metrics
- No blocked links
- Loop free via RPFC on SA-BMAC
- Symmetric unicast/mcast datapath between any two nodes provides closed OAM system
- unicast path now exists from every node to every other node

3. Use IS-IS to advertise new services communities of interest
  - MAC and ISID information flooded to the network
4. When nodes receive notice of a new service AND they are on the shortest path, update FDB
  - Unicast FIB entry - no flooding in BVPLS
  - Mcast FIB entry - per ISID group MAC

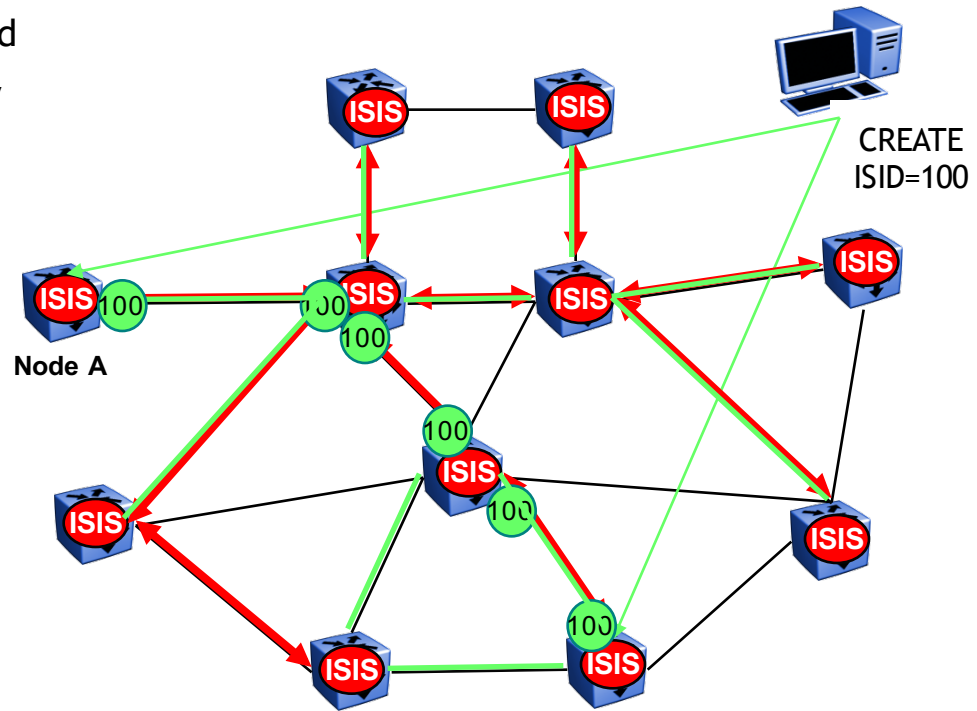

Shortest path tree to node A shown

# Shortest Path Bridging - SPT Example

Base SPBM Topology

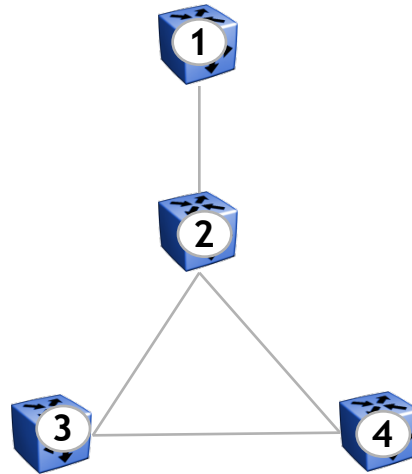

Path from 1 to 4 are symmetrical for SPT at node 1 and SPT at node 4. Same for all other node pairs.

SPT for node 1

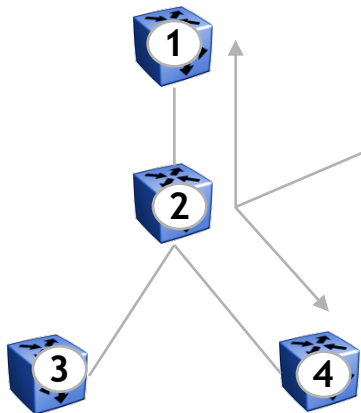

SPT for node 2

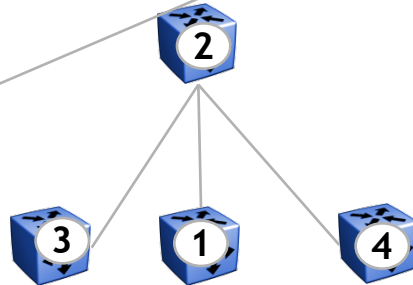

SPT for node 3

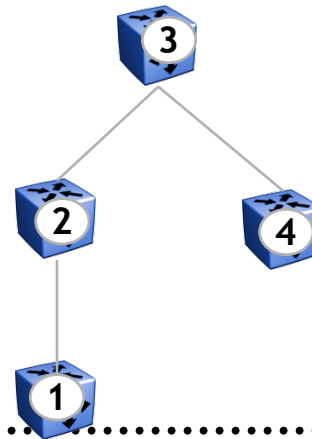

SPT for node 4

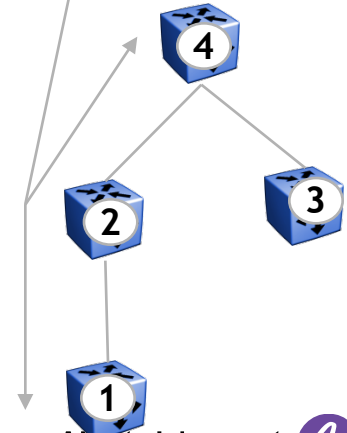

---

# 3.5 Summary

# Traditional Metro Ethernet Networks

---

## Summary of Issues:

- High Availability is difficult to achieve in networks running the Spanning Tree Protocol
- Scalability - IEEE 802.1q/802.1ad networks run into scalability limitations in terms of the number of supported services
  - Customer Ethernet frames are encapsulated in a provider Ethernet frame
- QoS - only very rudimentary traffic-engineering can be achieved in bridged Ethernet networks.
- A lot of deployed Ethernet switching platforms lack carrier-class capabilities required for the delivery of Carrier Ethernet services
- New extensions in IEEE 802.1ah address some limitations such as the number of service instances and MAC explosion problems
- New extensions in IEEE 802.1aq address the replacement of the Spanning Tree Protocol

## Audience Question 2

---

**Which IEEE standard defines Provider Bridging (Q-in-Q) ?**



## Audience Question 3

---

**What is the size of the I-SID field in IEEE 802.1ah?**





## 4. Delivering Ethernet over MPLS

# Agenda

---

- 4. Delivering Ethernet over MPLS
  - 4.1 Introduction to MPLS
  - 4.2 The Pseudowire Reference Model
  - 4.3 Ethernet Virtual Private Wire Service
  - 4.4 Ethernet Virtual Private LAN Service
  - 4.5 Scaling VPLS
  - 4.6 VPLS Topologies
  - 4.7 Resiliency Mechanisms

---

## 4.1 Introduction to MPLS

# Delivering Ethernet over MPLS

---

## MPLS Attributes

- Convergence: From “MPLS over everything” to “Everything over MPLS” !
  - One network, multiple services
- Excellent virtualisation capabilities
  - Today’s MPLS network can transport IP, ATM, Frame Relay and even TDM !
- Scalability
  - MPLS is used in some of the largest service provider networks in the world
- Advanced Traffic Engineering capabilities using RSVP-TE
- Rapid recovery based on MPLS Fast ReRoute (FRR)
  - Rapid restoration around failures by local action at the Points of Local Repair (PLRs)
  - Sub-50ms restoration on link/node failures is a key requirement for carriers who are used to such performance in their SONET/SDH networks
- Feature-richness
  - MPLS has 10 years of development behind it and continues to evolve today
- Layer 3 VPNs have already proven themselves as the killer app for MPLS - there is no reason why this success cannot be emulated by Layer 2 VPNs

# MPLS is truly Multi-Protocol

---

The “Multiprotocol” nature of MPLS:

- MPLS is multiprotocol in terms of both the layers above and below it !
- The ultimate technology for convergence

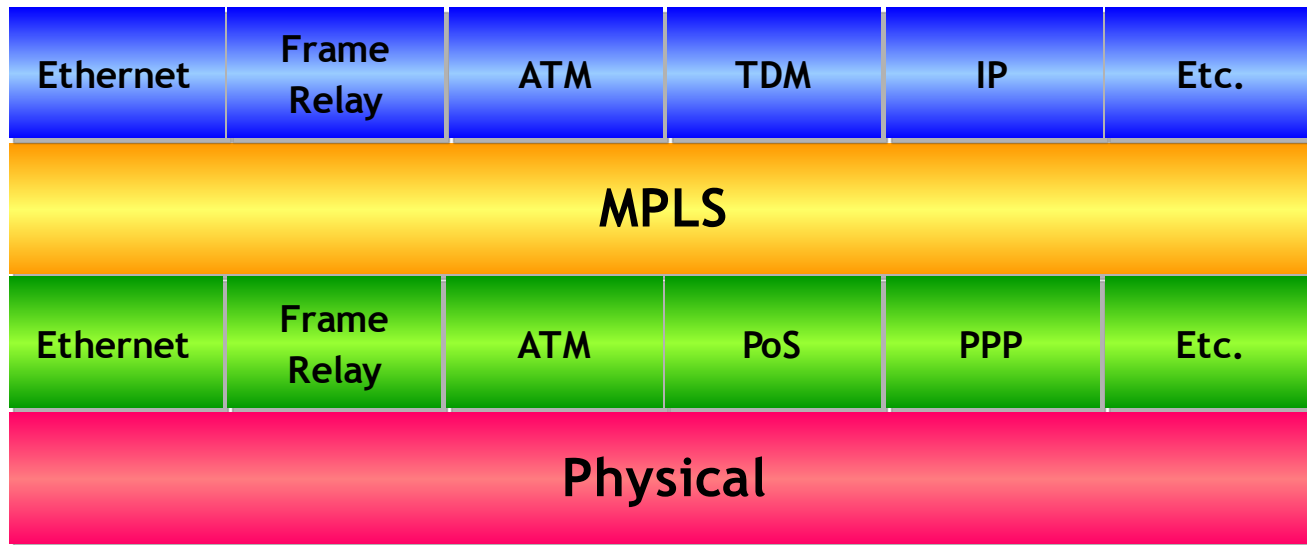

# MPLS Virtualisation

The virtualisation capabilities of MPLS:

- One common network supports multiple, different overlaid services

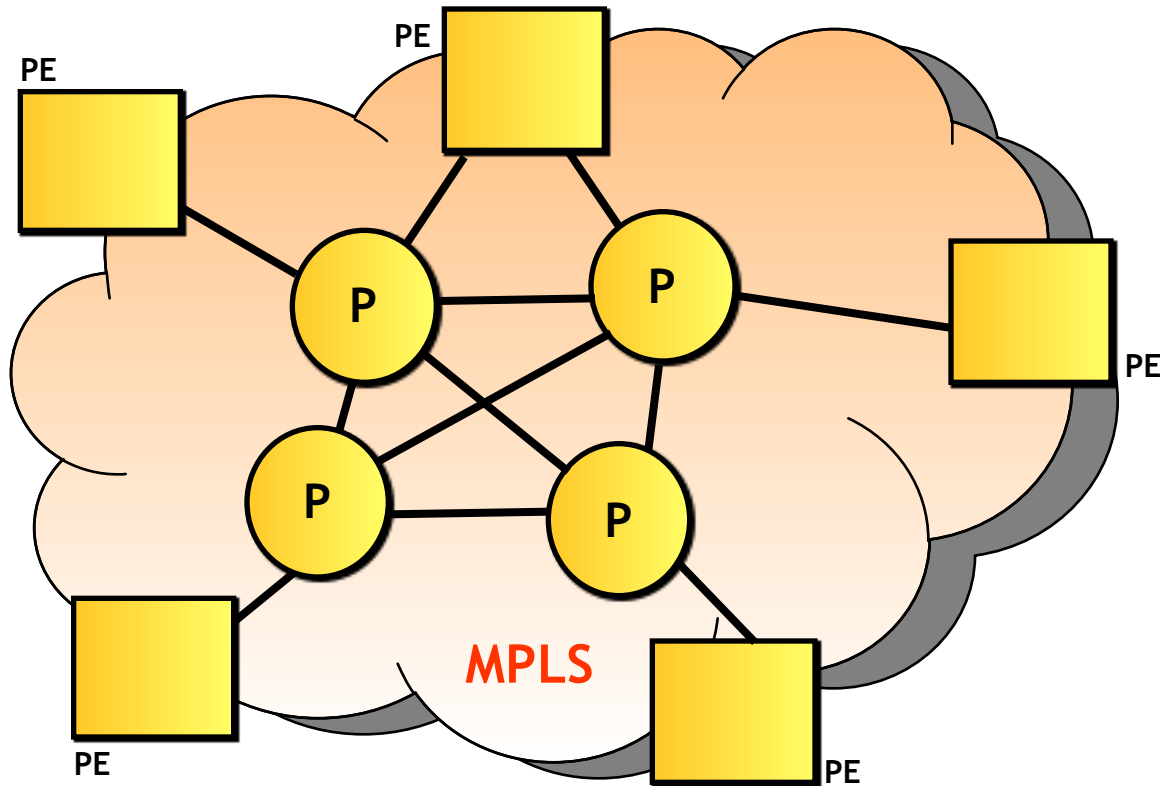

# MPLS Virtualisation

The virtualisation capabilities of MPLS:

- One common network supports multiple, different overlaid services

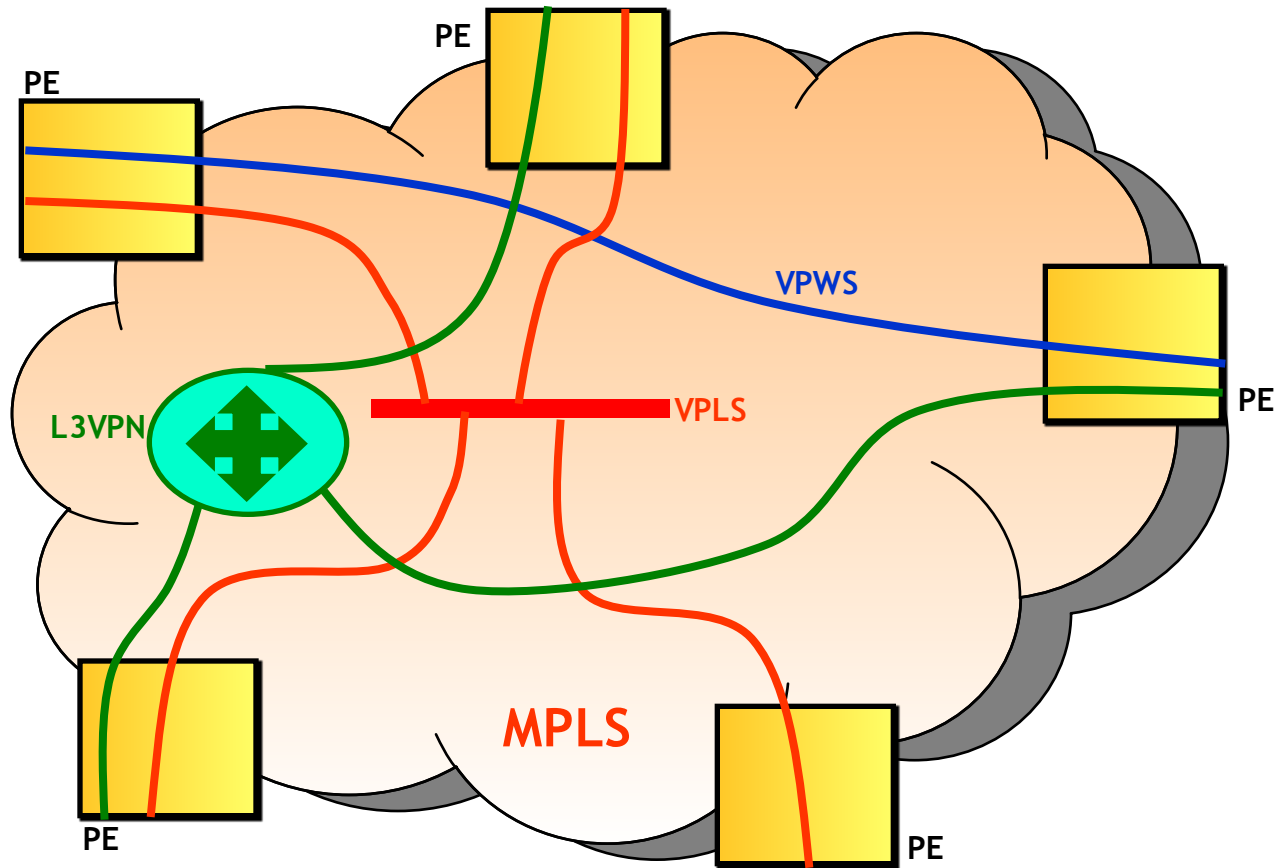

# MPLS Scalability

## MPLS Scalability:

- Service state is kept only on the Provider Edge devices
- The Provider (P) devices simply contain reachability information to each other and all PEs in the network
- The Provider Edge (PE) devices contain customer and service-specific state

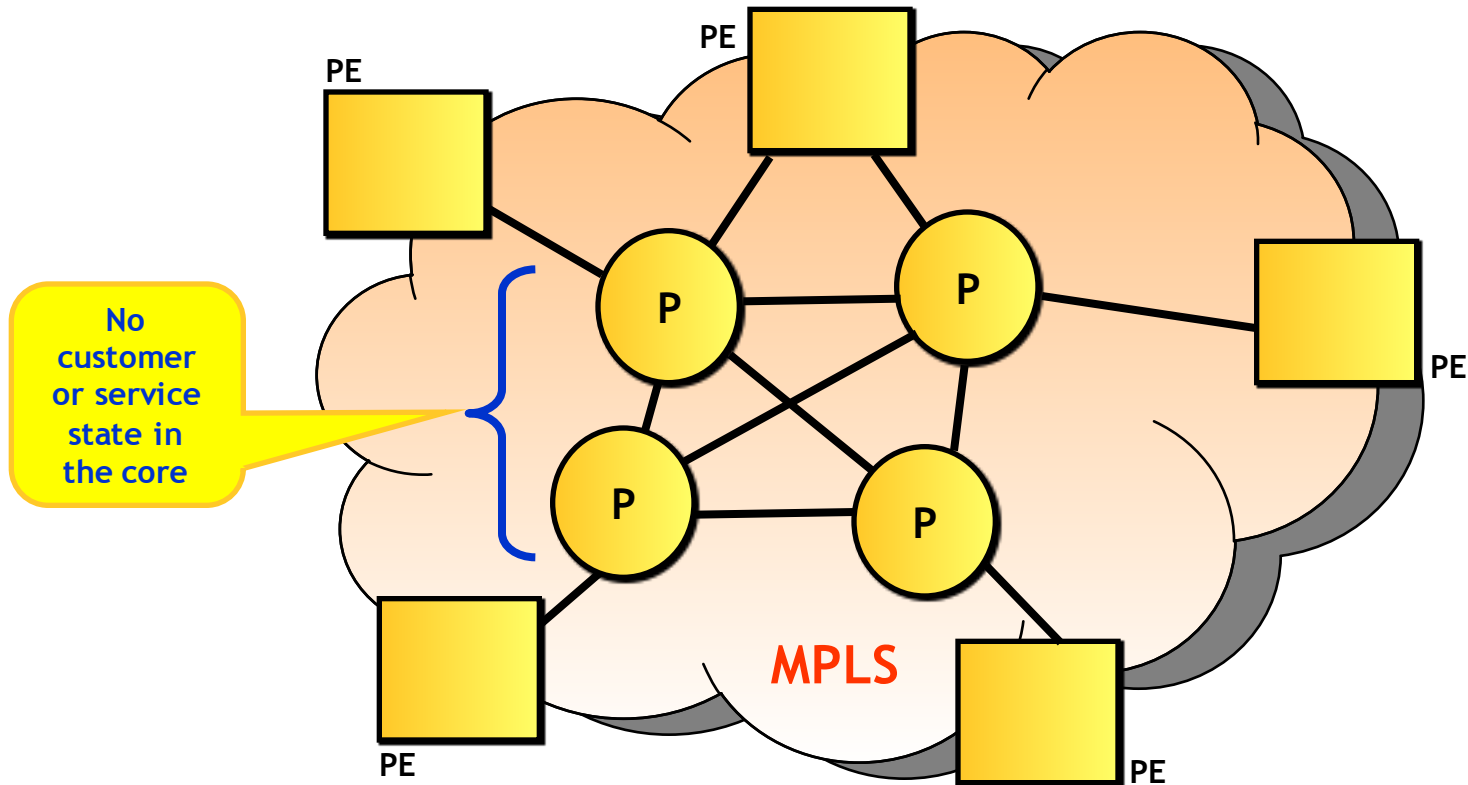



# MPLS Traffic-Engineering

## Traffic-Engineering capabilities

- The Problem: consider example below - all mission-critical traffic between nodes A and Z has to use the path A-D-E-F-Z, while all other traffic uses the path A-B-C-Z.

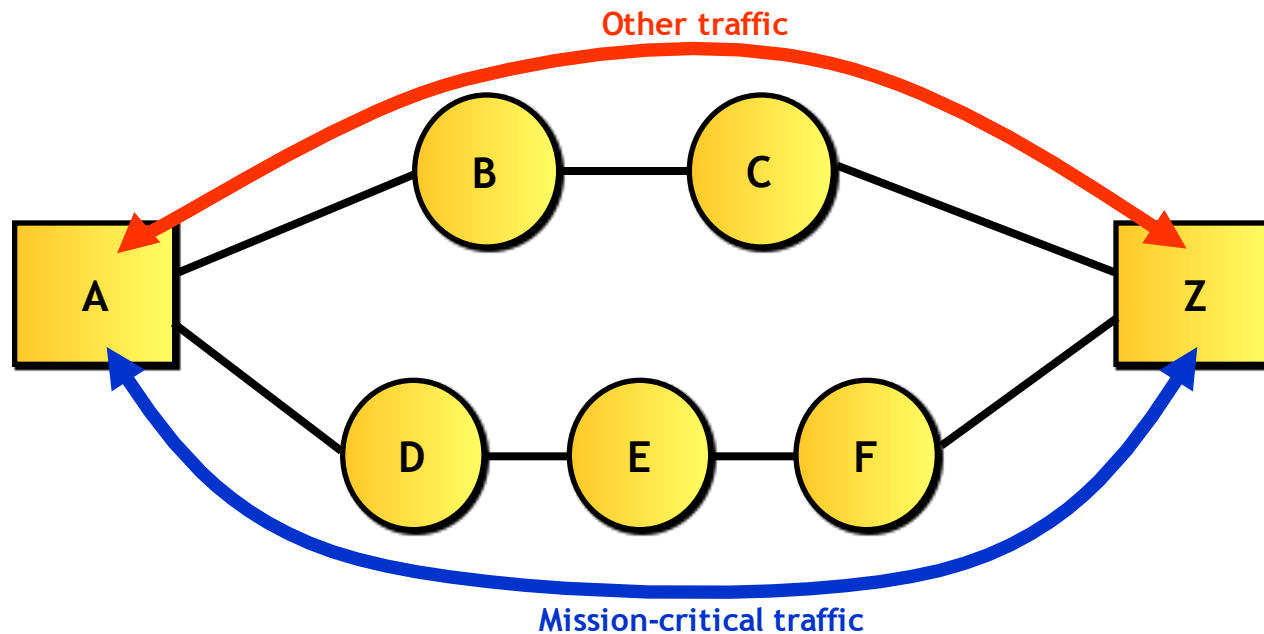

# MPLS Traffic-Engineering

## The IGP-based solution

- Use link metrics to influence traffic path
- It's all or nothing - Traffic cannot be routed selectively

## Other solutions

- Policy-based routing - will work but is cumbersome to manage and has to be carefully crafted to avoid routing loops

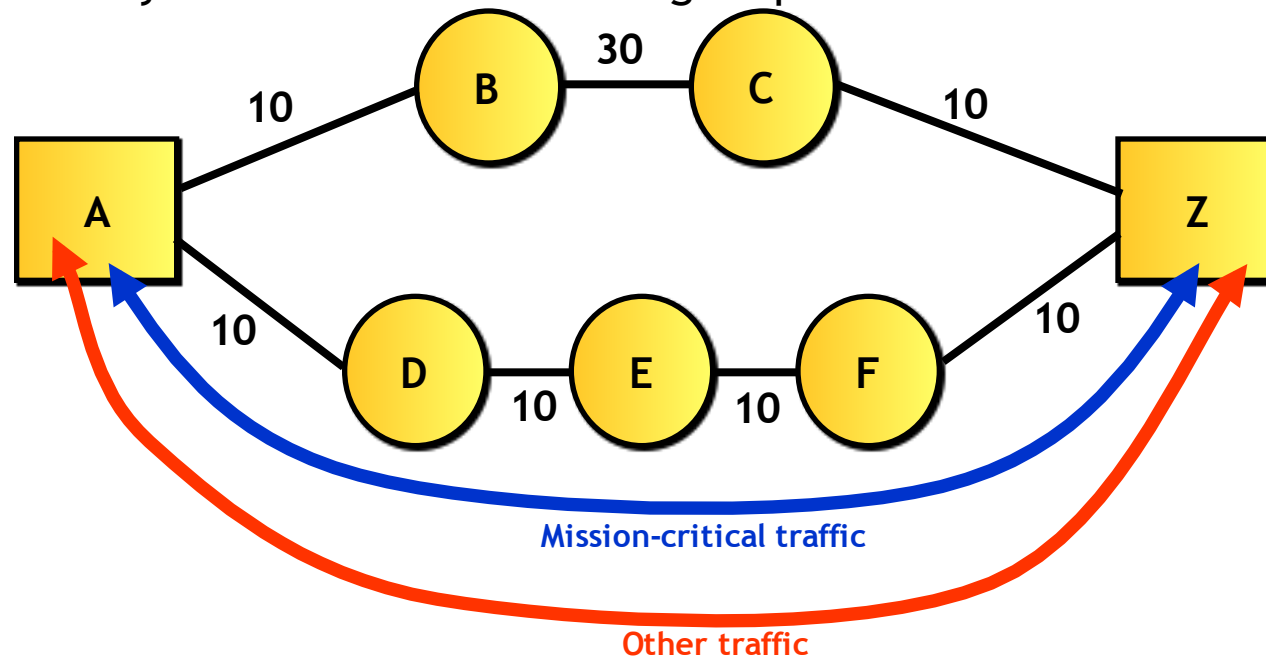

# MPLS Traffic-Engineering

## The MPLS solution

- Use constrained path routing to build Label Switched Paths (LSPs)
  - Constrain LSP1 to use only the “orange” physical links
  - Constrain LSP2 to use only the “blue” physical links
  - At the PEs, map the mission-critical traffic to LSP2 and...
  - ...all other traffic to LSP1

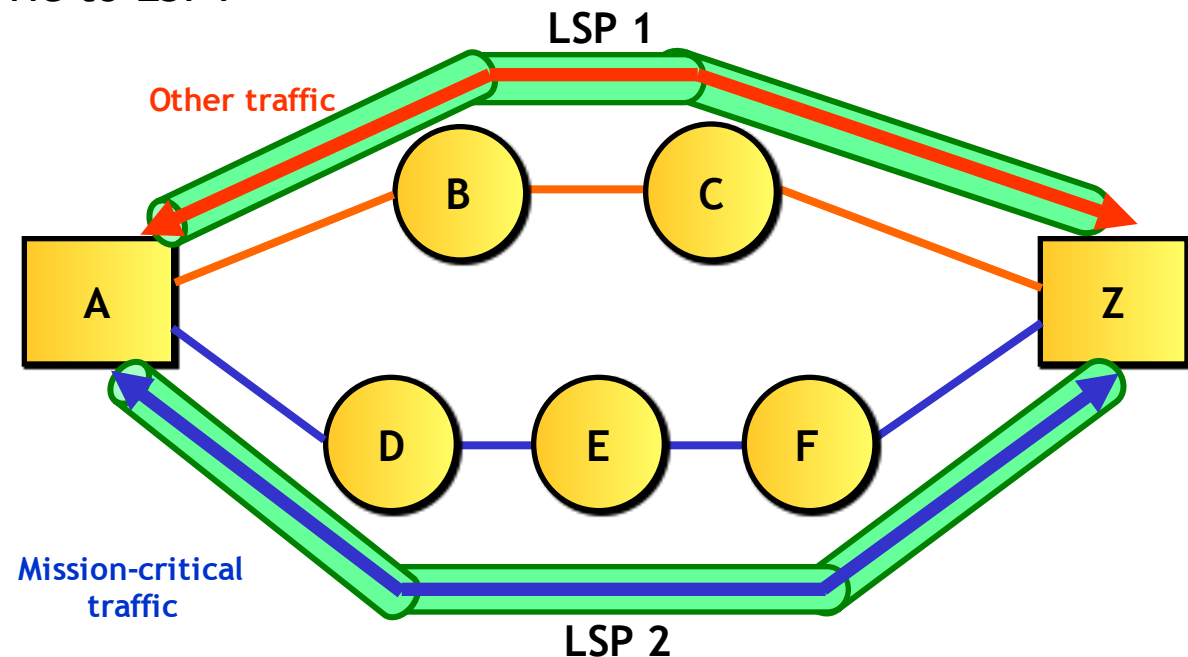

# MPLS Traffic-Engineering

---

## Recovery from failures - typical IGP

- Step 1 - Detection of the failure
  - One or more routers detect that a failure (link or node) has occurred
- Step 2 - Propagation of failure notification
  - The router(s) detecting the failure inform other routers in the domain about the failure
- Step 3 - Recomputation of Paths/Routes
  - All routers which receive the failure notification now have to recalculate new routes/paths by running SPF algorithms etc
- Step 4 - Updating of the Forwarding Table
  - Once new routes are computed, they are downloaded to the routers' forwarding table, in order to allow them to be used
- All of this takes time...

# MPLS Traffic-Engineering

## Failure and Recovery Example - IGP-based

- What happens immediately after the link between C and Z fails ?
  - Step 1 - Assuming a loss of signal (or similar physical indication) nodes C and Z immediately detect that the link is down
  - Node A does not know that the link is down yet and keeps sending traffic destined to node Z to Node C. Assuming that node C has not completed step 4 yet, this traffic is dropped.

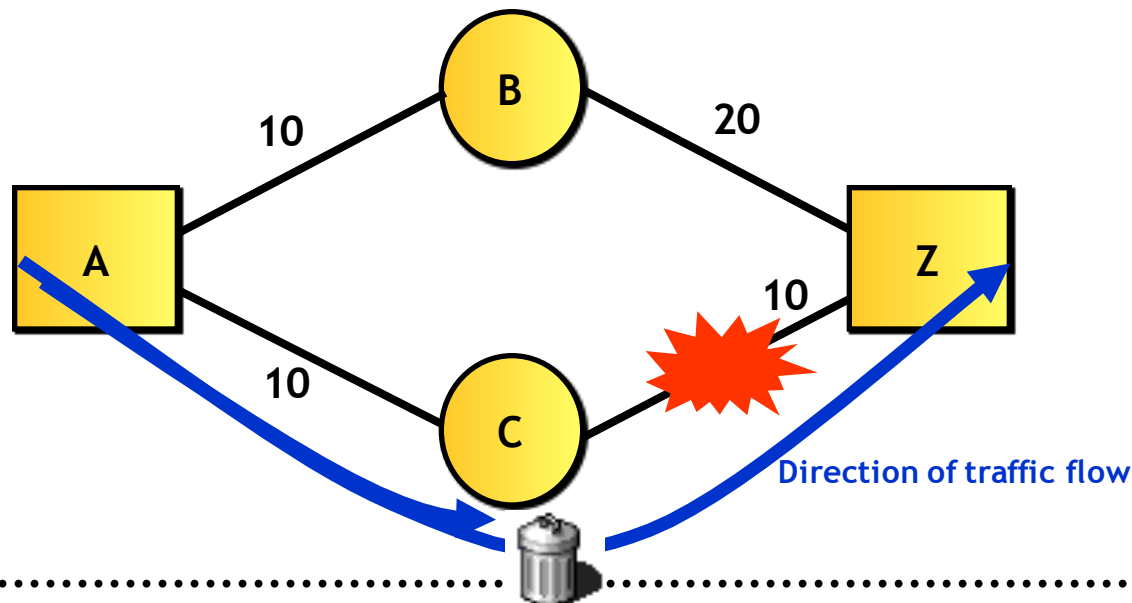

# MPLS Traffic-Engineering

## Failure and Recovery Example (continued) - IGP-based

- Node C (and node Z) will be the first to recalculate its routing table and update its forwarding table (step 4).
  - In the meantime, Node A does not know that the link is down yet and keeps sending traffic destined to node Z to Node C. Given that node C has completed step 4, it now believes (quite correctly) that the best path to Z is via node A. BUT - node A still believes that the best path to node Z is via node C so it sends the traffic right back to node C. We have a transient loop (micro-loop) ....
  - The loop resolves itself as soon as node A updates its forwarding table but in the meantime, valuable packets have been dropped

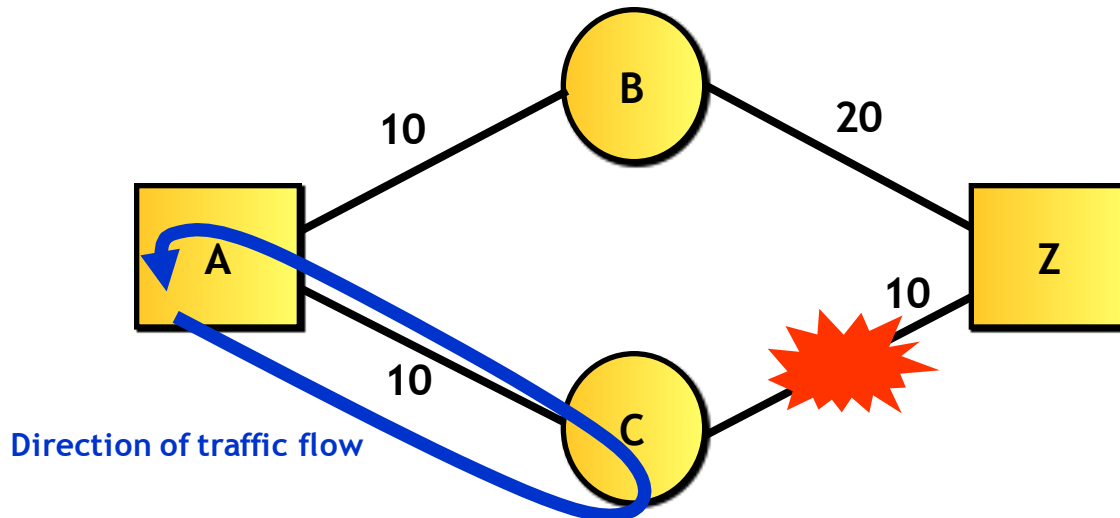

# MPLS Traffic-Engineering

## Failure and Recovery Example (continued)

- Node A and all other nodes eventually update their forwarding tables and all is well again.
- But the damage is already done. . .

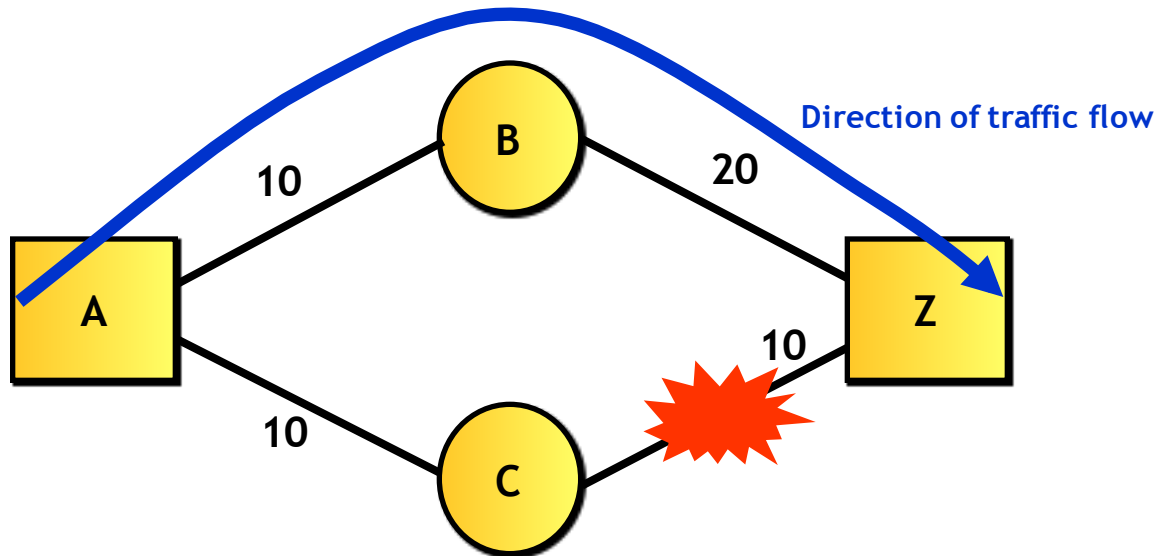

# MPLS Traffic-Engineering

---

## Recovery from failures - how can MPLS help ?

- RSVP-TE Fast Re-Route (FRR) pre-computes detours around potential failure points such as next-hop nodes and links
- When link or node failures occur, the routers (Points of Local Repair) directly connected to the failed link rapidly (sub-50ms) switch all traffic onto the detour paths.
- The network eventually converges and the head-end router (source of the traffic) switches traffic onto the most optimal path. Until that is done, traffic flows over the potentially sub-optimal detour path BUT the packet loss is kept to a minimum



# MPLS Traffic-Engineering

## Failure and Recovery Example - with MPLS FRR

- Node C pre-computes and builds a detour around link C-Z

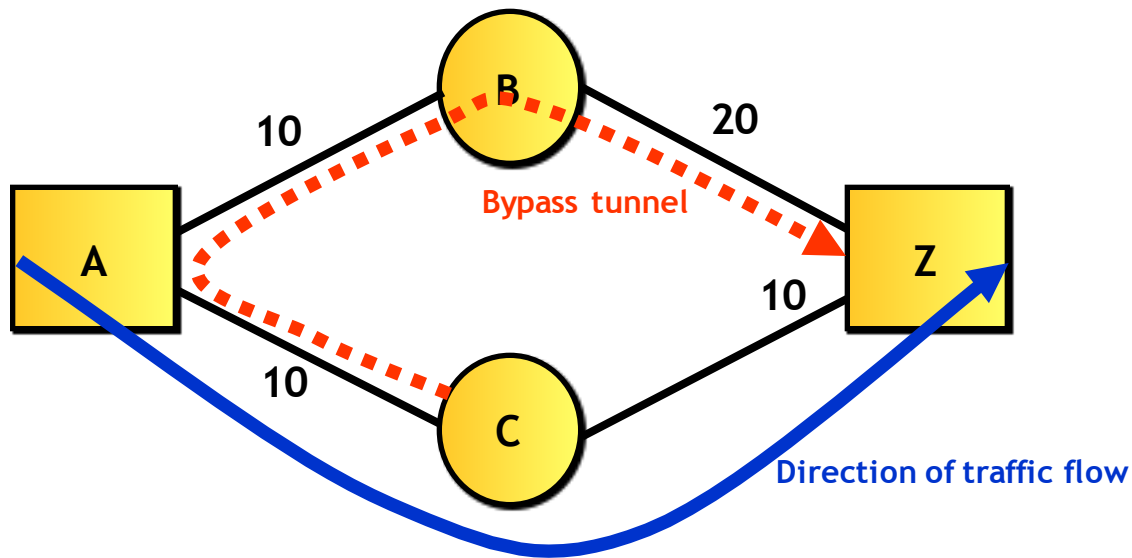

# MPLS Traffic-Engineering

## Failure and Recovery Example - with MPLS FRR

- When link C-Z fails, node C reroutes traffic onto the detour tunnel
- Traffic does a U-turn but still makes it to the destination

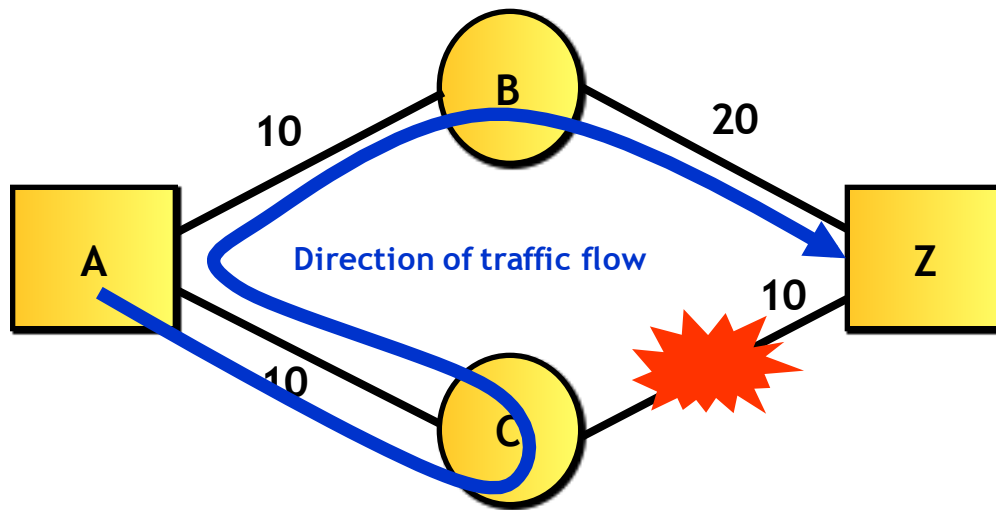

## Audience Question 4

---

**What is the size of the MPLS label stack entry ?  
And the MPLS label itself ?**



---

## 4.2 The Pseudowire Reference Model

# The Pseudowire Reference Model

---

## Pseudowires:

- Key enabling technology for delivering Ethernet services over MPLS
- Specified by the **pwe3** working group of the IETF
- Originally designed for Ethernet over MPLS (EoMPLS) - initially called Martini tunnels
- Now extended to many other services - ATM, FR, Ethernet, TDM
- Encapsulates and transports service-specific PDUs/Frames across a Packet Switched Network (PSN) tunnel
- The use of pseudowires for the emulation of point-to-point services is referred to as Virtual Private Wire Service (VPWS)
- IETF definition (RFC3985):

“...a mechanism that emulates the essential attributes of a telecommunications service (such as a T1 leased line or Frame Relay) over a PSN. PWE3 is intended to provide only the minimum necessary functionality to emulate the wire with the required degree of faithfulness for the given service definition.”

# PWE3 Reference Model

## Generic PWE3 Architectural Reference Model:

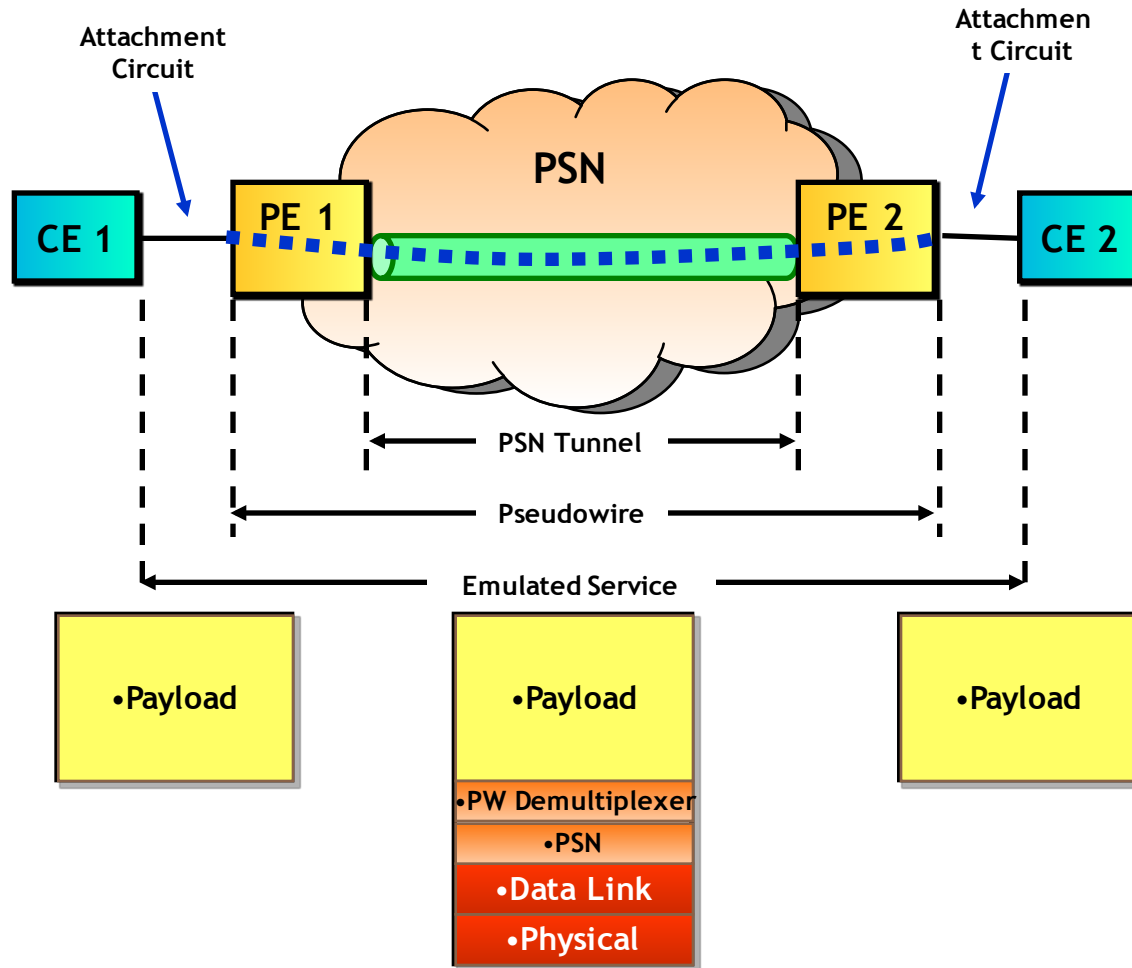

# PWE3 Terminology

---

## Pseudowire Terminology

- Attachment circuit (AC)
  - The physical or virtual circuit attaching a CE to a PE.
- Customer Edge (CE)
  - A device where one end of a service originates and/or terminates.
- Forwarder (FWRD)
  - A PE subsystem that selects the PW to use in order to transmit a payload received on an AC.
- Packet Switched Network (PSN)
  - Within the context of PWE3, this is a network using IP or MPLS as the mechanism for packet forwarding.
- Provider Edge (PE)
  - A device that provides PWE3 to a CE.
- Pseudo Wire (PW)
  - A mechanism that carries the essential elements of an emulated service from one PE to one or more other PEs over a PSN.
- PSN Tunnel
  - A tunnel across a PSN, inside which one or more PWs can be carried.
- PW Demultiplexer
  - Data-plane method of identifying a PW terminating at a PE.

# Pseudowire Protocol Layering

## Pseudowire - Protocol Layering:

- The PW demultiplexing layer provides the ability to deliver multiple PWs over a single PSN tunnel

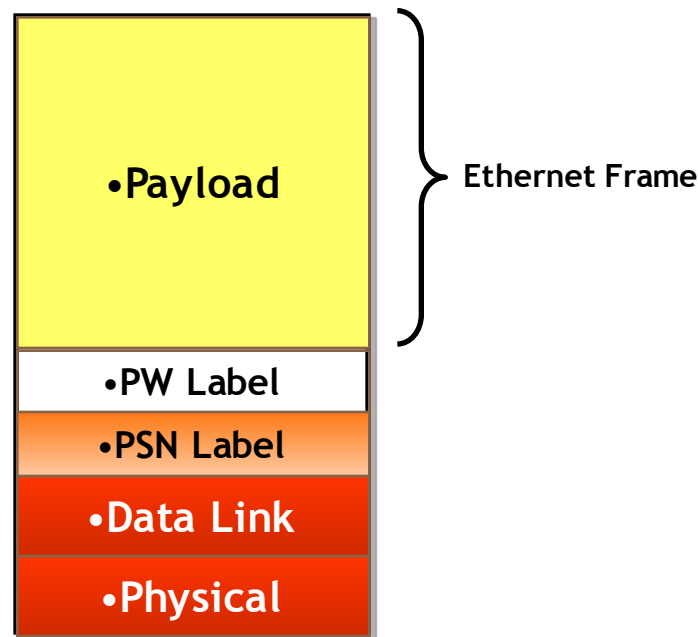

**Ethernet over MPLS PSN**



---

## 4.3 Ethernet Virtual Private Wire Service (VPWS)

# Ethernet Virtual Private Wire Service

---

## Ethernet Pseudowires:

- Encapsulation specified in RFC4448 - “Encapsulation Methods for Transport of Ethernet over MPLS Networks”
- Ethernet pseudowires carry Ethernet/802.3 Protocol Data Units (PDUs) over an MPLS network
- Enables service providers to offer “emulated” Ethernet services over existing MPLS networks
- RFC4448 defines a point-to-point Ethernet pseudowire service
- Operates in one of two modes:
  - Tagged mode - In tagged mode, each frame **MUST** contain at least one 802.1Q VLAN tag, and the tag value is meaningful to the two PW termination points.
  - Raw mode - On a raw mode PW, a frame **MAY** contain an 802.1Q VLAN tag, but if it does, the tag is not meaningful to the PW termination points, and passes transparently through them.

# Ethernet Virtual Private Wire Service

---

## Ethernet Pseudowires (continued):

- Two types of services:
  - “port-to-port” - all traffic ingressing each attachment circuit is transparently conveyed to the other attachment circuit, where each attachment circuit is an entire Ethernet port
  - “Ethernet VLAN to VLAN” - all traffic ingressing each attachment circuit is transparently conveyed to the other attachment circuit, where each attachment circuit is a VLAN on an Ethernet port
    - In this service instance, the VLAN tag may be stripped on ingress and then re-imposed on egress.
    - Alternatively, the VLAN tag may be stripped on ingress and a completely different VLAN ID imposed on egress, allowing VLAN re-write
    - The VLAN ID is locally significant to the Ethernet port

# PWE3 Reference Model for Ethernet VPWS

## PWE3 Architectural Reference Model for Ethernet Pseudowires

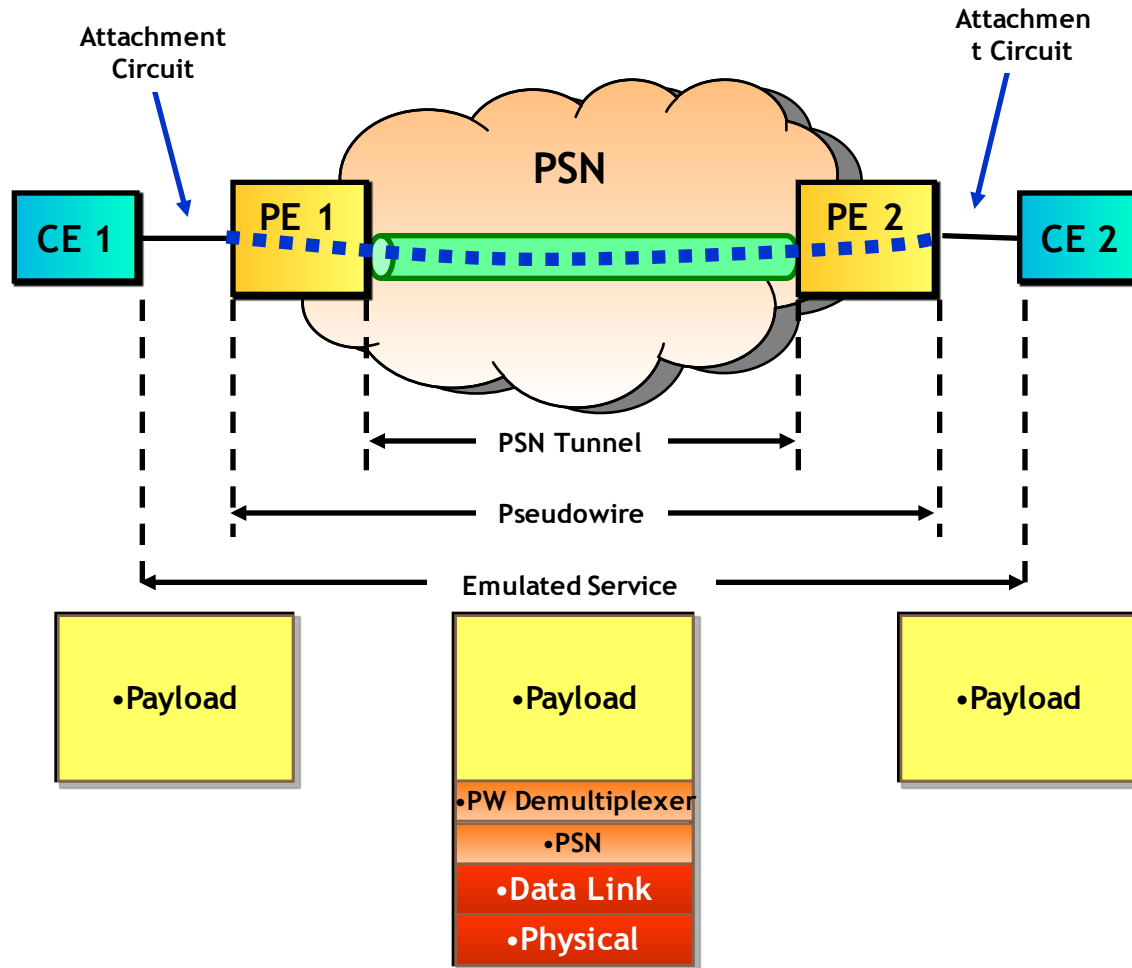

# Ethernet Virtual Private Wire Service

Ethernet PWE3 Protocol Stack Reference Model:

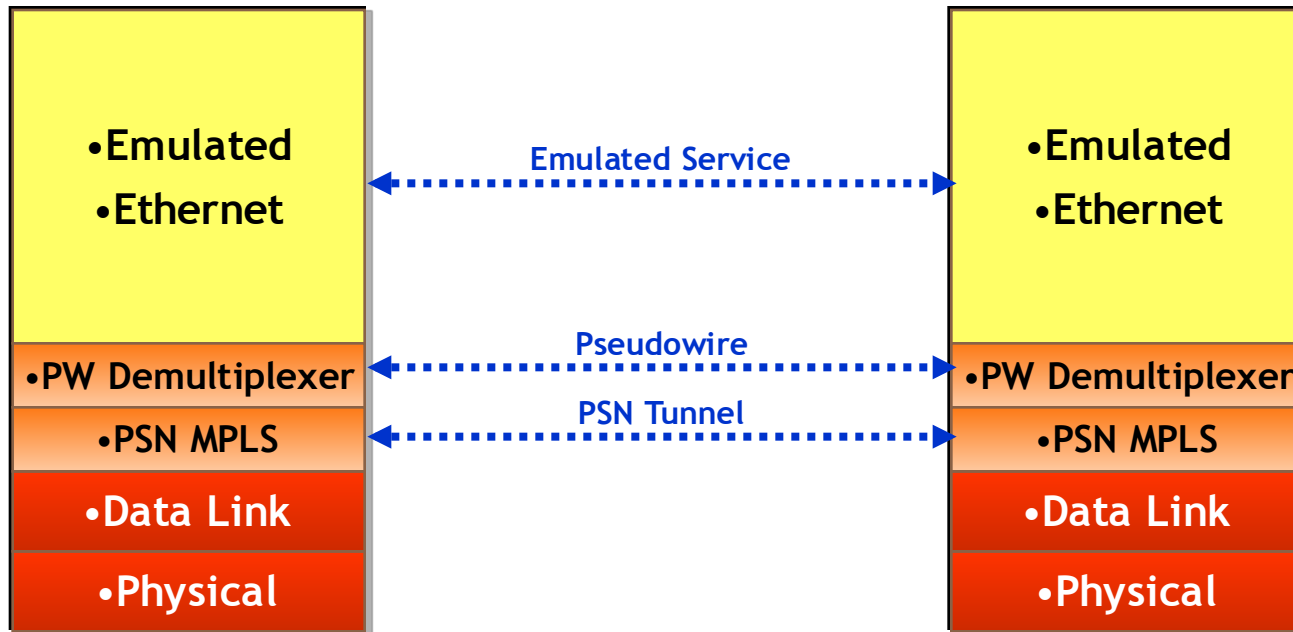

# Ethernet VPWS Example 1

## Example 1: Ethernet VPWS port-to-port (traffic flow from CE1 to CE2)

### PE1 Config:

Service ID: 1000  
Service Type: Ethernet VPWS  
(port-to-port)  
PSN Label for PE2: 1029  
PW Label from PE2: 6775  
Port: 1/2/1

### PE2 Config:

Service ID: 1000  
Service Type: Ethernet VPWS  
(port-to-port)  
PSN Label for PE1: 4567  
PW Label from PE1: 10978  
Port: 3/2/0

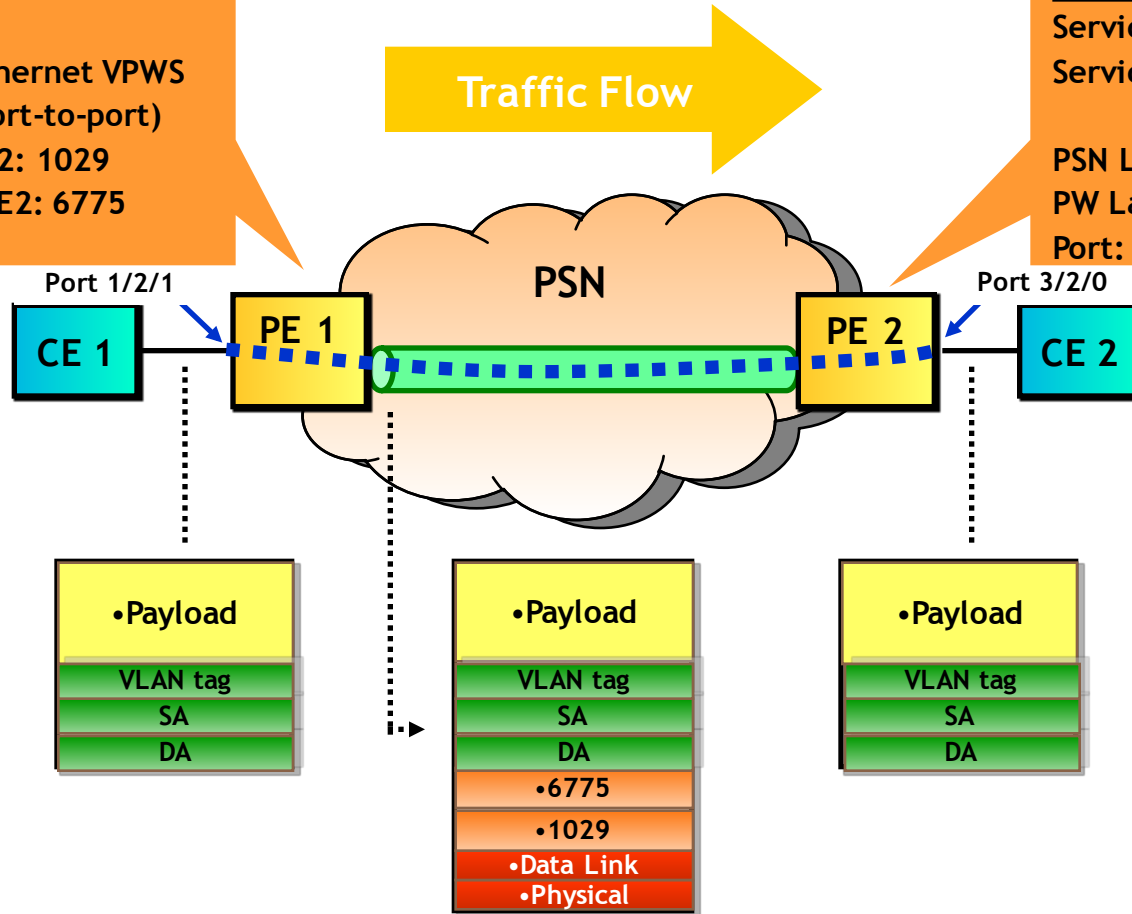

# Ethernet VPWS Example 1

## Example 1: Ethernet VPWS port-to-port (traffic flow from CE2 to CE1)

### PE1 Config:

Service ID: 1000  
Service Type: Ethernet VPWS  
(port-to-port)  
PSN Label for PE2: 1029  
PW Label from PE2: 6775  
Port: 1/2/1

### PE2 Config:

Service ID: 1000  
Service Type: Ethernet VPWS  
(port-to-port)  
PSN Label for PE1: 4567  
PW Label from PE1: 10978  
Port: 3/2/0

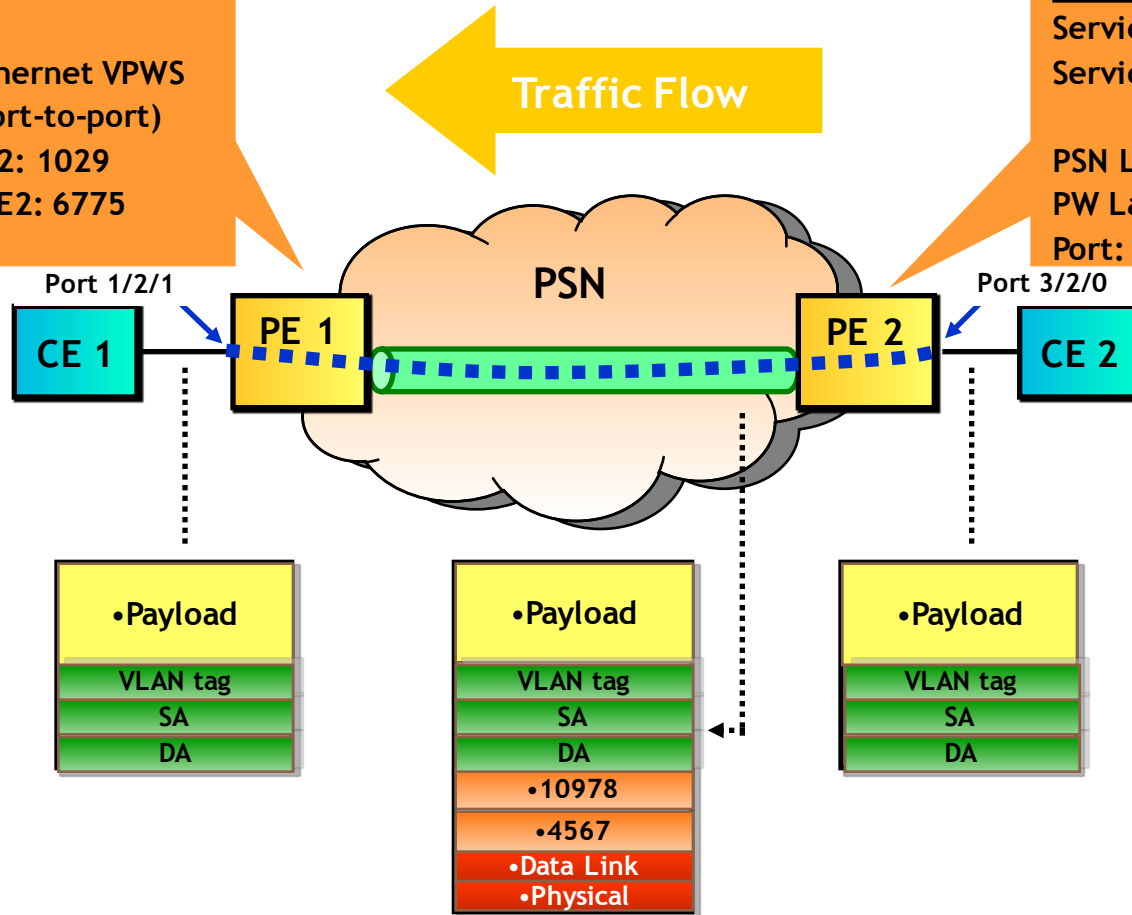

# Ethernet VPWS Example 2

## Example 2: Ethernet VPWS VLAN-based (traffic flow from CE1 to CE2)

### PE1 Config:

Service ID: 2000  
Service Type: Ethernet VPWS  
(VLAN-100)  
PSN Label for PE2: 1029  
PW Label from PE2: 5879  
Port: 1/2/1 VLAN 100

### PE2 Config:

Service ID: 2000  
Service Type: Ethernet VPWS  
(VLAN-200)  
PSN Label for PE1: 4567  
PW Label from PE1: 21378  
Port: 3/2/0 VLAN 200

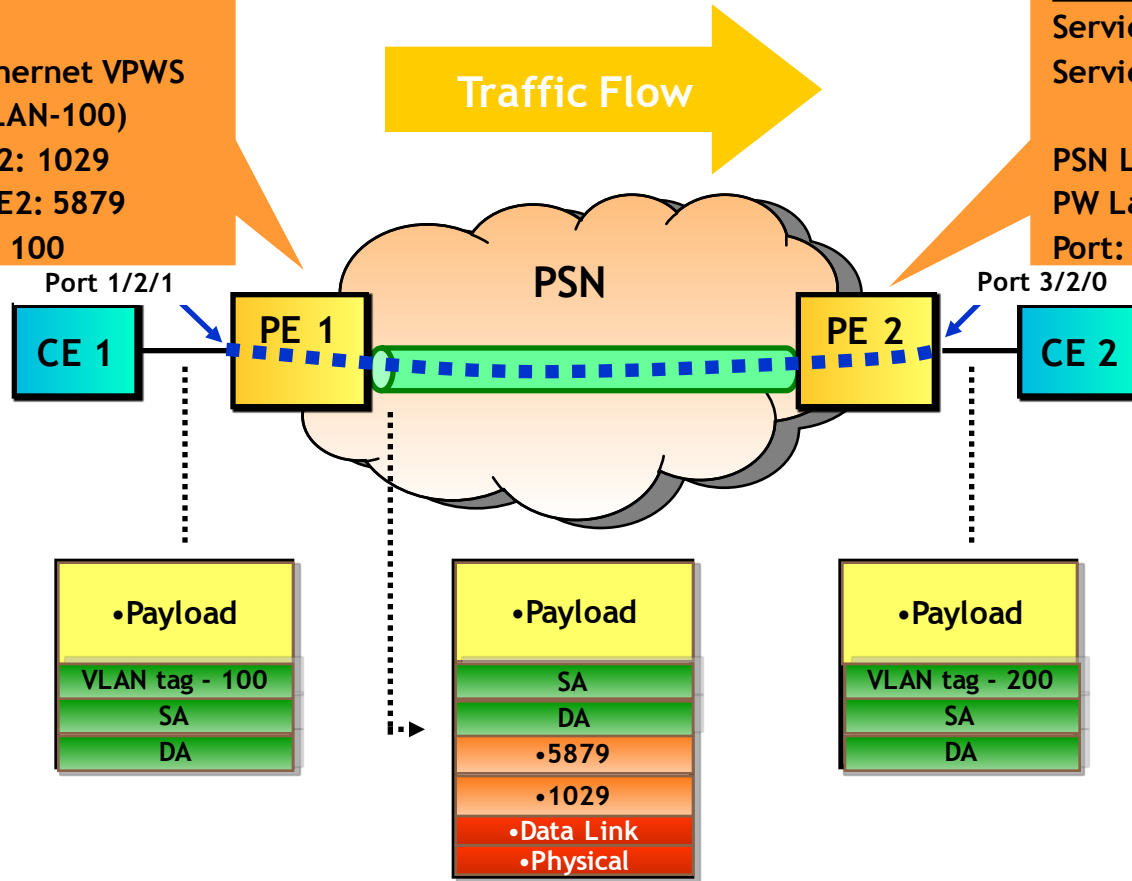



# Ethernet VPWS Example 2

## Example 2: Ethernet VPWS VLAN-based (traffic flow from CE2 to CE1)

### PE1 Config:

Service ID: 2000  
Service Type: Ethernet VPWS  
(VLAN-100)  
PSN Label for PE2: 1029  
PW Label from PE2: 5879  
Port: 1/2/1 VLAN 100

### PE2 Config:

Service ID: 1000  
Service Type: Ethernet VPWS  
(VLAN-200)  
PSN Label for PE1: 4567  
PW Label from PE1: 21378  
Port: 3/2/0 VLAN 200

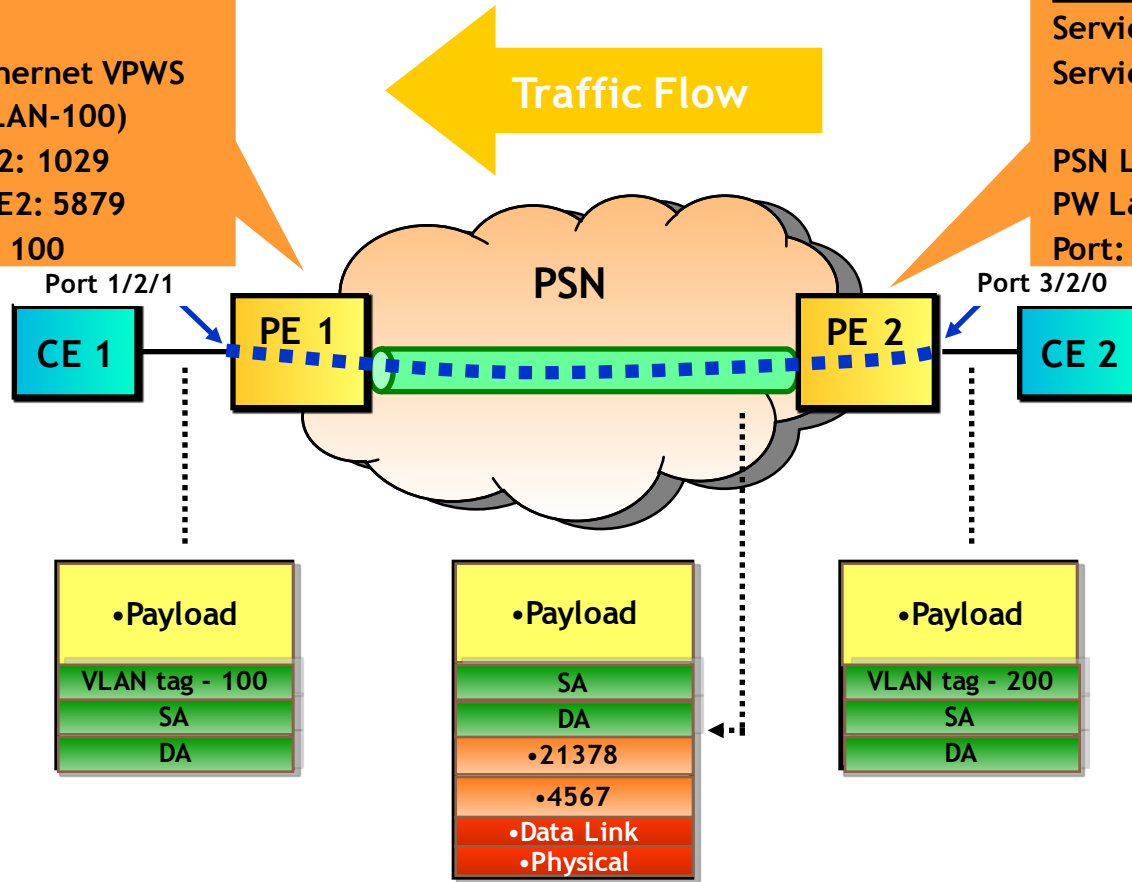

# Ethernet Virtual Private Wire Service

---

## Ethernet Pseudowires - Setup and Maintenance:

- Signalling specified in RFC4447 - “Pseudowire Setup and Maintenance Using the Label Distribution Protocol (LDP)”
- The MPLS Label Distribution Protocol, LDP [RFC5036], is used for setting up and maintaining the pseudowires
  - PW label bindings are distributed using the LDP downstream unsolicited mode
  - PEs establish an LDP session using the LDP Extended Discovery mechanism a.k.a Targeted LDP or tLDP
- The PSN tunnels are established and maintained separately by using any of the following:
  - The Label Distribution Protocol (LDP)
  - The Resource Reservation Protocol with Traffic Engineering (RSVP-TE)
  - Static labels

# Ethernet Virtual Private Wire Service

## Ethernet Pseudowires - Setup and Maintenance:

- LDP distributes FEC to label mappings using the PWid FEC Element (popularly known as FEC Type 128)
- Both pseudowire endpoints have to be provisioned with the same 32-bit identifier for the pseudowire to allow them to obtain a common understanding of which service a given pseudowire belongs to.

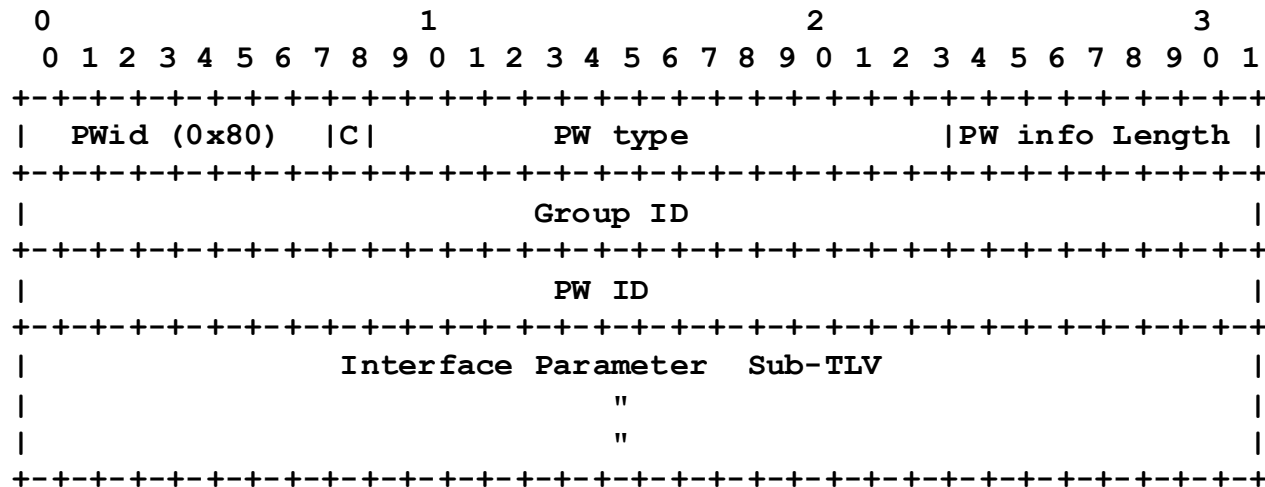

# Ethernet Virtual Private Wire Service

---

## Ethernet Pseudowires - Setup and Maintenance:

- A new TLV, the Generalized Pwid FEC Element (popularly known as FEC Type 129) has also been developed but is not widely deployed as yet
- The Generalized Pwid FEC element requires that the PW endpoints be uniquely identified; the PW itself is identified as a pair of endpoints. In addition, the endpoint identifiers are structured to support applications where the identity of the remote endpoints needs to be auto-discovered rather than statically configured.

# Ethernet Virtual Private Wire Service

## Ethernet Pseudowires - Setup and Maintenance:

- The Generalized Pwid FEC Element (popularly known as FEC Type 129)

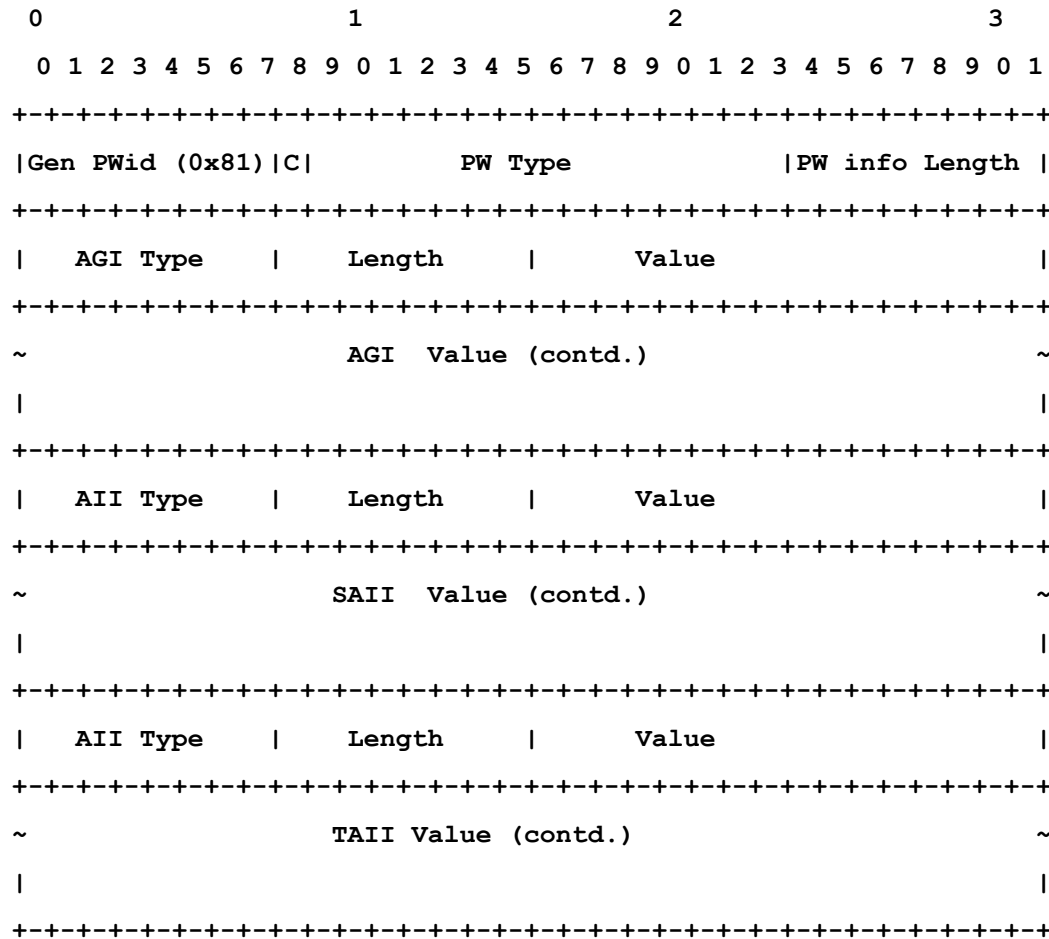

## Audience Question 5

---

**What protocol is used to exchange pseudowire labels between provider edge routers ?**



---

## 4.4 Ethernet Virtual Private LAN Service (VPLS)

# Ethernet Virtual Private LAN Service

---

## Ethernet VPLS:

- Two variants
  - RFC4762 - Virtual Private LAN Service (VPLS) Using Label Distribution Protocol (LDP) Signaling. We will concentrate on this variant in the rest of this tutorial
  - RFC4761 - Virtual Private LAN Service (VPLS) Using BGP for Auto-Discovery and Signaling



# Ethernet Virtual Private LAN Service

---

## Definition:

- A VPLS creates an emulated **private** LAN segment for a given set of users.
- It creates a Layer 2 broadcast domain that is fully capable of learning and forwarding on Ethernet MAC addresses and that is closed to a given set of users. Multiple VPLS services can be supported from a single Provider Edge (PE) node.
- The primary motivation behind VPLS is to provide connectivity between geographically dispersed customer sites across MANs and WANs, as if they were connected using a LAN.
- The main intended application for the end-user can be divided into the following two categories:
  - Connectivity between customer routers: LAN routing application
  - Connectivity between customer Ethernet switches: LAN switching application

# VPLS Benefits

---

## Benefits for the customer:

- **Simplicity**
  - Behaves like an “ethernet switch in the sky”
  - No routing interaction with the provider
  - Clear demarcation between subscriber and provider
  - Layer 3 agnostic
- **Scalable**
  - Provider configures site connectivity only
  - Hierarchy reduces number of sites touched
- **Multi-site connectivity**
  - On the fly connectivity via Ethernet bridging

# VPLS Topological Model

---

## Topological Model for VPLS (customer view)

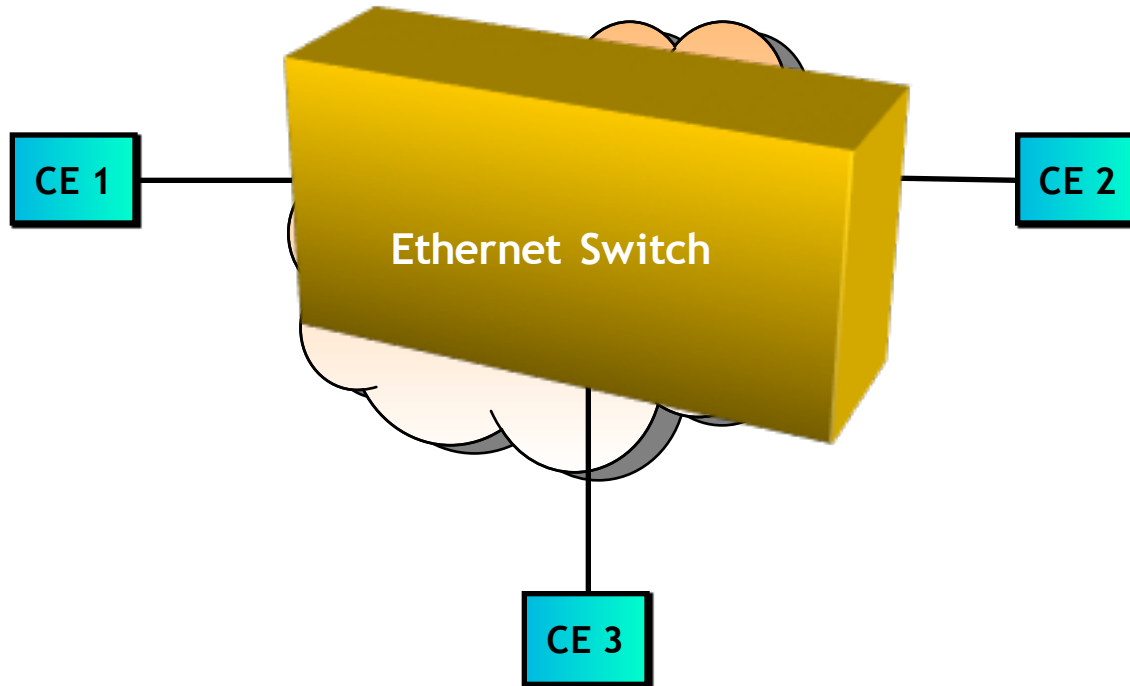

# VPLS Topological Model

## Topological Model for VPLS (provider view)

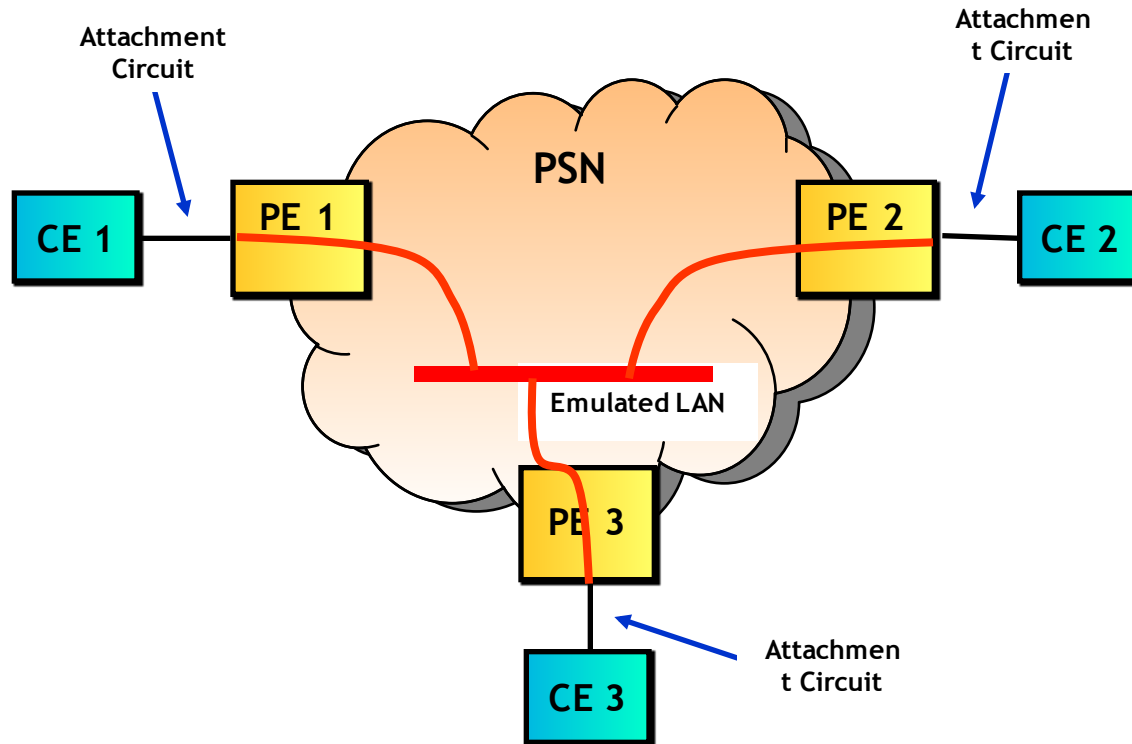

# Constructing VPLS Services

## PSN Tunnels and Pseudowire Constructs for VPLS:

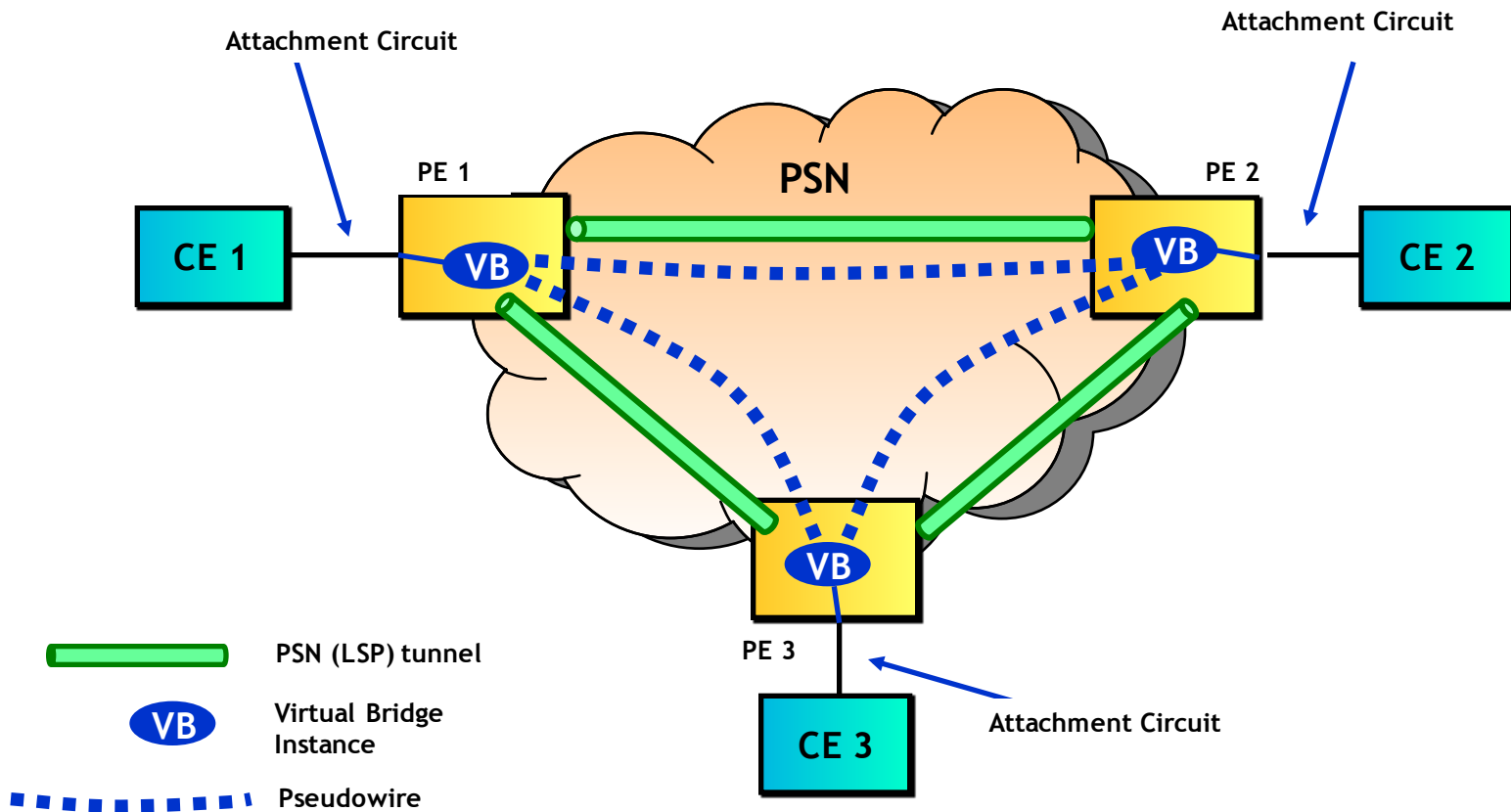

# VPLS PE Functions

---

## Provider Edge Functions:

- PE interfaces participating in a VPLS instance are able to flood, forward, and filter Ethernet frames, like a standard Ethernet bridged port
- Many forms of Attachment Circuits are acceptable, as long as they carry Ethernet frames:
  - Physical Ethernet ports
  - Logical (tagged) Ethernet ports
  - ATM PVCs carrying Ethernet frames
  - Ethernet Pseudowire
- Frames sent to broadcast addresses and to unknown destination MAC addresses are flooded to all ports:
  - Attachment Circuits
  - Pseudowires to all other PE nodes participating in the VPLS service
- PEs have the capability to associate MAC addresses with Pseudowires

# VPLS PE Functions

---

## Provider Edge Functions (continued):

- Address learning:
  - Unlike BGP VPNs [RFC4364], reachability information is not advertised and distributed via a control plane.
  - Reachability is obtained by standard learning bridge functions in the data plane.
  - When a packet arrives on a PW, if the source MAC address is unknown, it is associated with the PW, so that outbound packets to that MAC address can be delivered over the associated PW.
  - When a packet arrives on an AC, if the source MAC address is unknown, it is associated with the AC, so that outbound packets to that MAC address can be delivered over the associated AC.

# VPLS Signalling

## VPLS Mechanics:

- Bridging capable PE routers are connected with a full mesh of MPLS LSP tunnels
- Per-Service pseudowire labels are negotiated using RFC 4447 techniques
- Replicates unknown/broadcast traffic in a service domain
- MAC learning over tunnel & access ports
- Separate FIB per VPLS for private communication

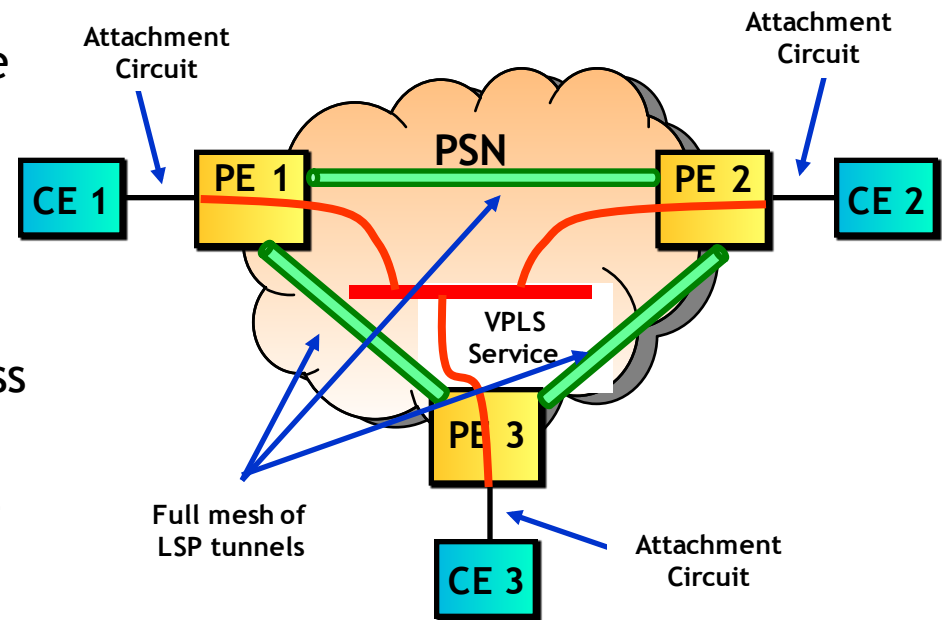



# VPLS Signalling

## Tunnel establishment

- LDP:
  - MPLS paths based on IGP reachability
  - RSVP: traffic engineered MPLS paths with bandwidth & link constraints, and fast reroute alternatives

## Pseudowire establishment

- LDP: point-to-point exchange of PW ID, labels, MTU

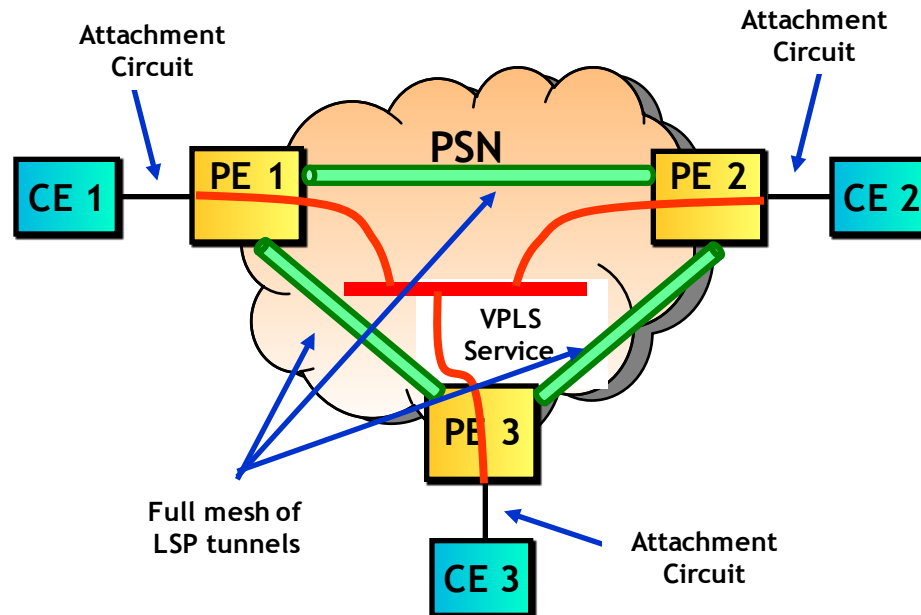

# VPLS Signalling

A full mesh of pseudowires is established between all PEs participating in the VPLS service:

- Each PE initiates a targeted LDP session to the far-end System IP (loopback) address
- Tells far-end what PW label to use when sending packets for each service

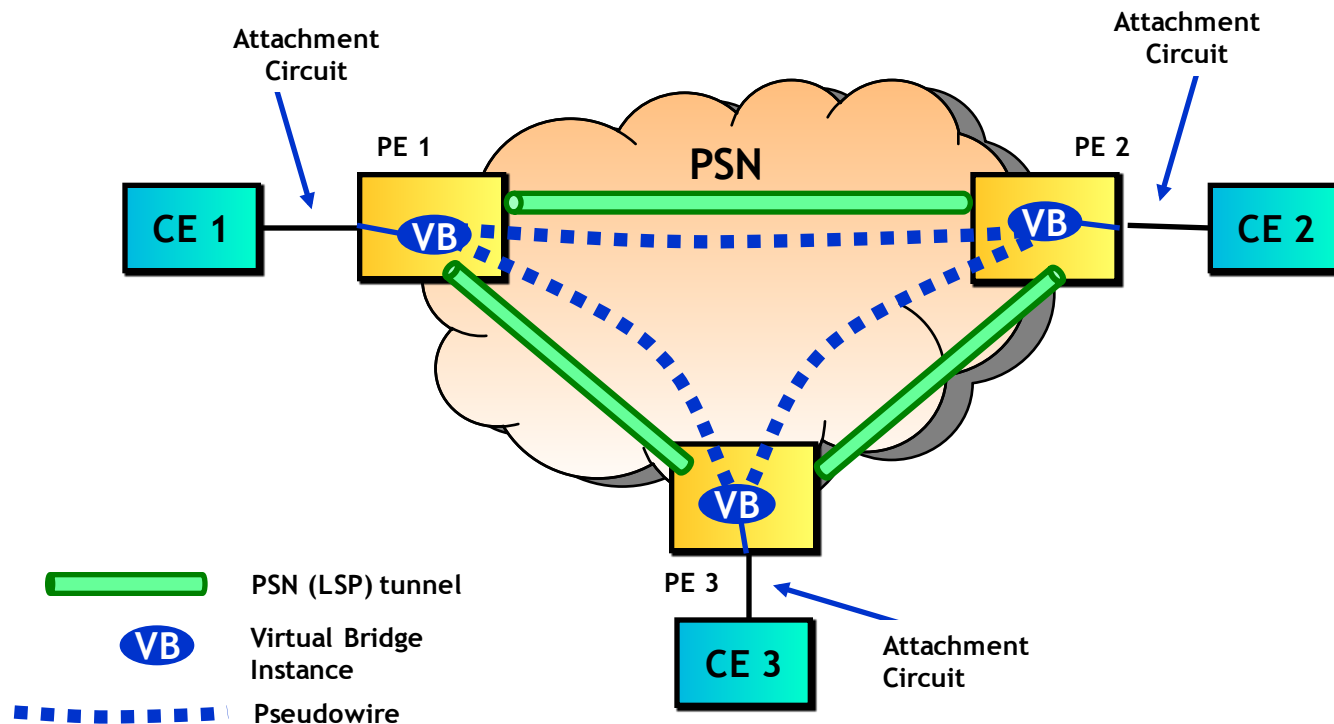

# VPLS Signalling

---

## Why a full mesh of pseudowires?

- If the topology of the VPLS is not restricted to a full mesh, then it may be that for two PEs not directly connected via PWs, they would have to use an intermediary PE to relay packets
- A loop-breaking protocol, such as the Spanning Tree Protocol, would be required
- With a full-mesh of PWs, every PE is now directly connected to every other PE in the VPLS via a PW; there is no longer any need to relay packets
- The loop-breaking rule now becomes the "split horizon" rule, whereby a PE **MUST NOT** forward traffic received from one PW to another in the same VPLS mesh
  - Does this remind you of a similar mechanism used in IP networks ? The `ibgp` full-mesh !

# VPLS Pseudowire Signalling

---

## Ethernet Pseudowires - Setup and Maintenance:

- Signalling specified in RFC4447 - “Pseudowire Setup and Maintenance Using the Label Distribution Protocol (LDP)”
- The MPLS Label Distribution Protocol, LDP [RFC5036], is used for setting up and maintaining the pseudowires
  - PW label bindings are distributed using the LDP downstream unsolicited mode
  - PEs establish an LDP session using the LDP Extended Discovery mechanism a.k.a Targeted LDP or tLDP
- The PSN tunnels are established and maintained separately by using any of the following:
  - The Label Distribution Protocol (LDP)
  - The Resource Reservation Protocol with Traffic Engineering (RSVP-TE)
  - Static labels

# VPLS Pseudowire Signalling

## Ethernet Pseudowires - Setup and Maintenance:

- LDP distributes FEC to label mappings using the PWid FEC Element (popularly known as FEC Type 128)
- Both pseudowire endpoints have to be provisioned with the same 32-bit identifier for the pseudowire to allow them to obtain a common understanding of which service a given pseudowire belongs to.

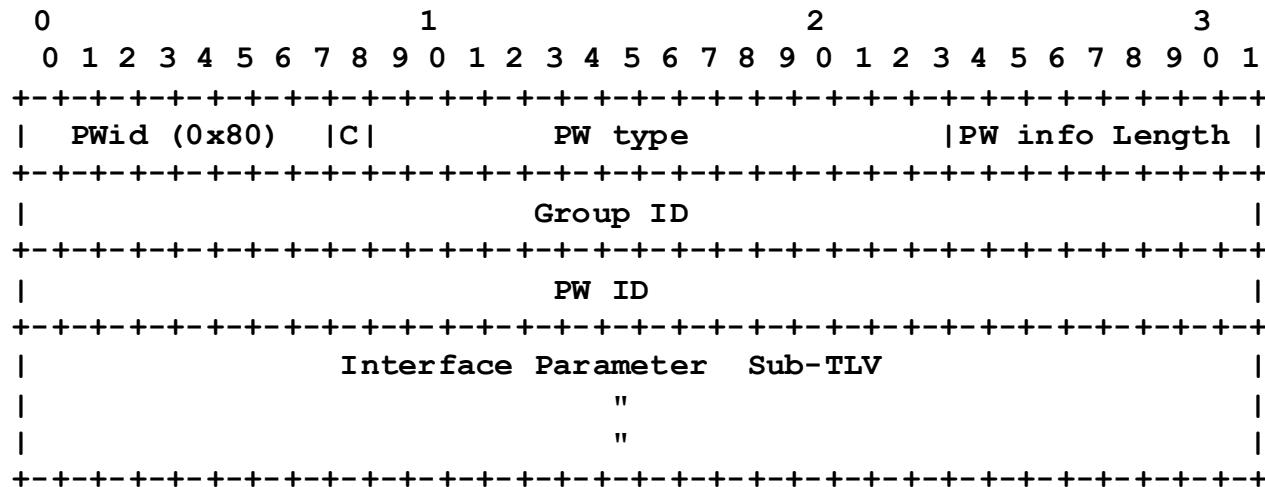

# VPLS Pseudowire Signalling

---

## Ethernet Pseudowires - Setup and Maintenance:

- A new TLV, the Generalized PWid FEC Element (popularly known as FEC Type 129) has also been developed but is not widely deployed as yet
- The Generalized PWid FEC element requires that the PW endpoints be uniquely identified; the PW itself is identified as a pair of endpoints. In addition, the endpoint identifiers are structured to support applications where the identity of the remote endpoints needs to be auto-discovered rather than statically configured.

# VPLS Pseudowire Signalling

## Ethernet Pseudowires - Setup and Maintenance:

- The Generalized Pwid FEC Element (popularly known as FEC Type 129)

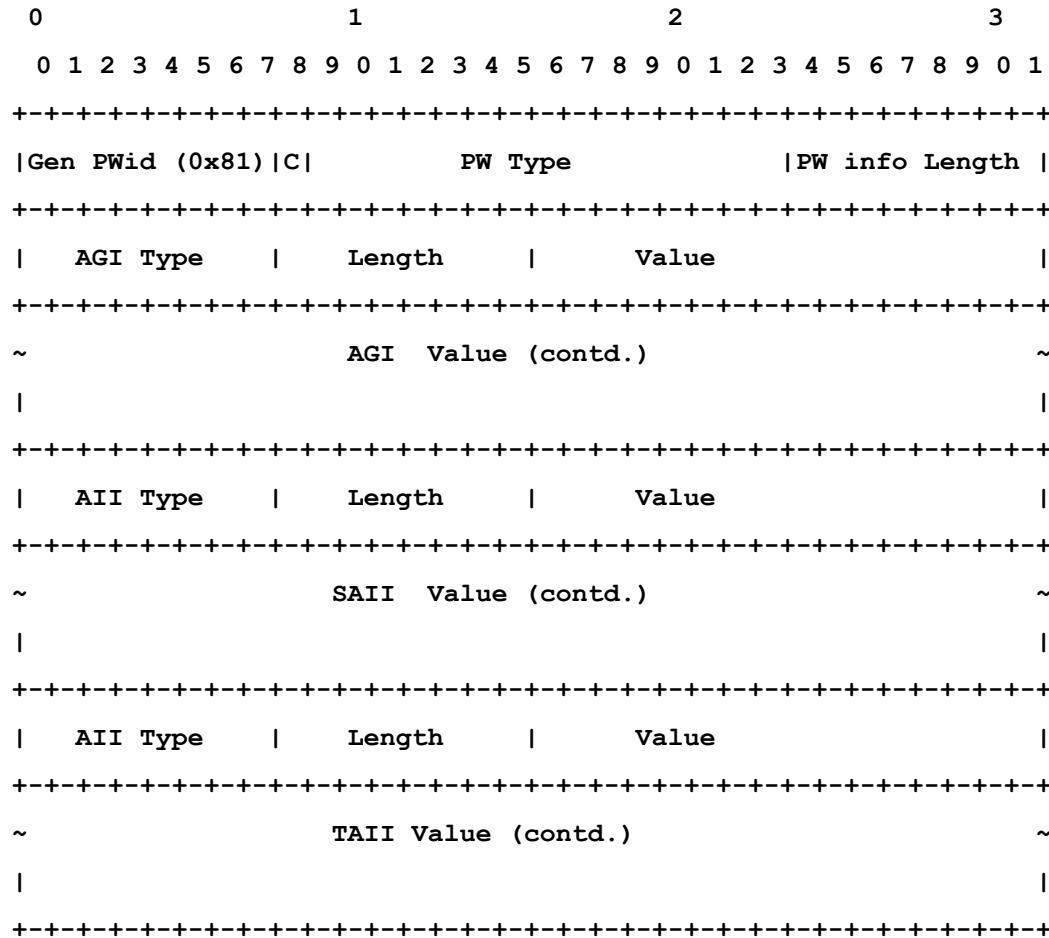

# Ethernet VPLS Signalling Example

## PE1 Config:

Service ID: 1001  
Service Type: Ethernet VPLS  
PSN Label for PE2: 1029  
PSN Label for PE3: 9178  
PW Label from PE2: 6775  
PW Label from PE3: 10127  
Port: 1/2/1

## PE2 Config:

Service ID: 1001  
Service Type: Ethernet VPLS  
PSN Label for PE1: 4567  
PSN Label for PE3: 11786  
PW Label from PE1: 10978  
PW Label from PE3: 4757  
Port: 3/2/0

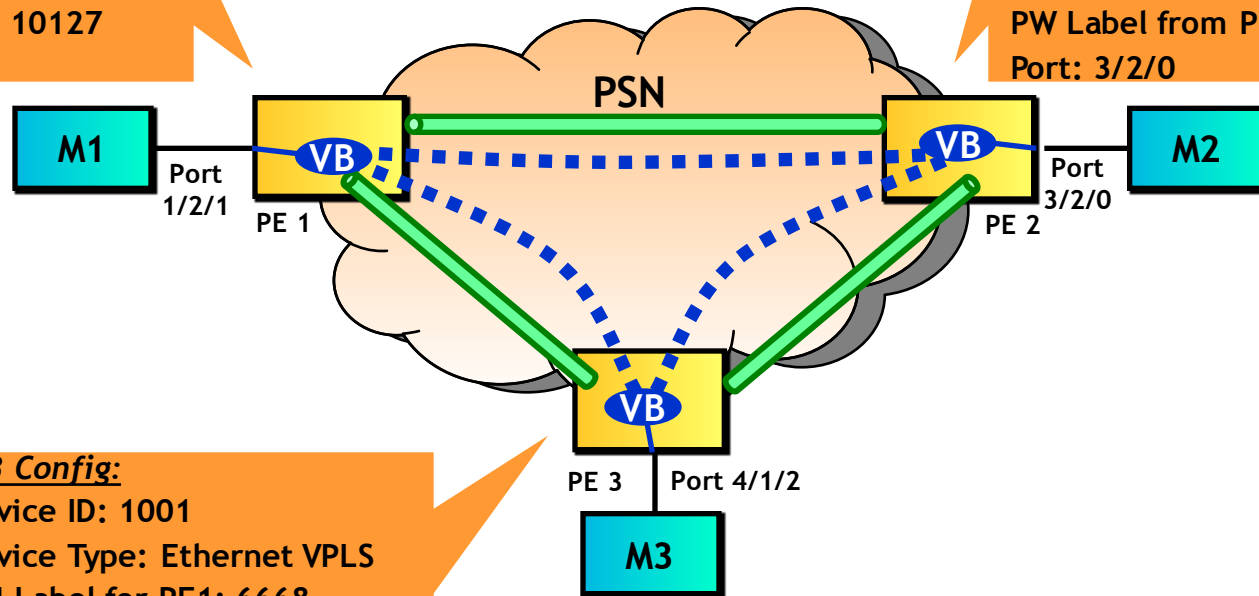

## PE3 Config:

Service ID: 1001  
Service Type: Ethernet VPLS  
PSN Label for PE1: 6668  
PSN Label for PE2: 12812  
PW Label from PE1: 4568  
PW Label from PE3: 10128  
Port: 4/1/2



# VPLS Packet Walkthrough and MAC Learning Example

## Packet Walkthrough for VPLS Service-id 1001

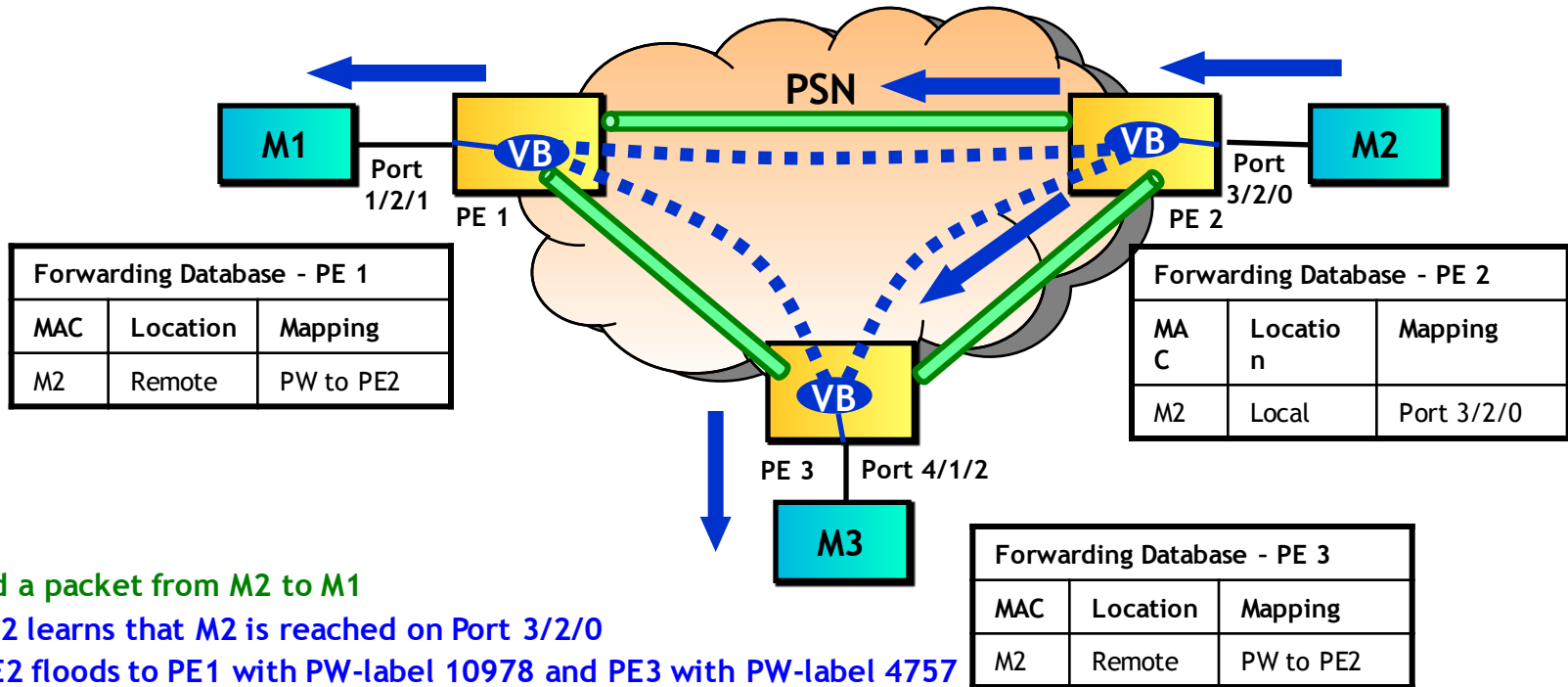

### Send a packet from M2 to M1

- PE2 learns that M2 is reached on Port 3/2/0
- PE2 floods to PE1 with PW-label 10978 and PE3 with PW-label 4757
- PE1 learns from the PW-label 10978 that M2 is behind PE2
- PE1 sends on Port 1/2/1
- PE3 learns from the PW-label 4757 M2 is behind PE2
- PE3 sends on Port 4/1/2
- M1 receives packet

# VPLS Packet Walkthrough and MAC Learning Example (cont.)

## Packet Walkthrough for VPLS Service-id 1001

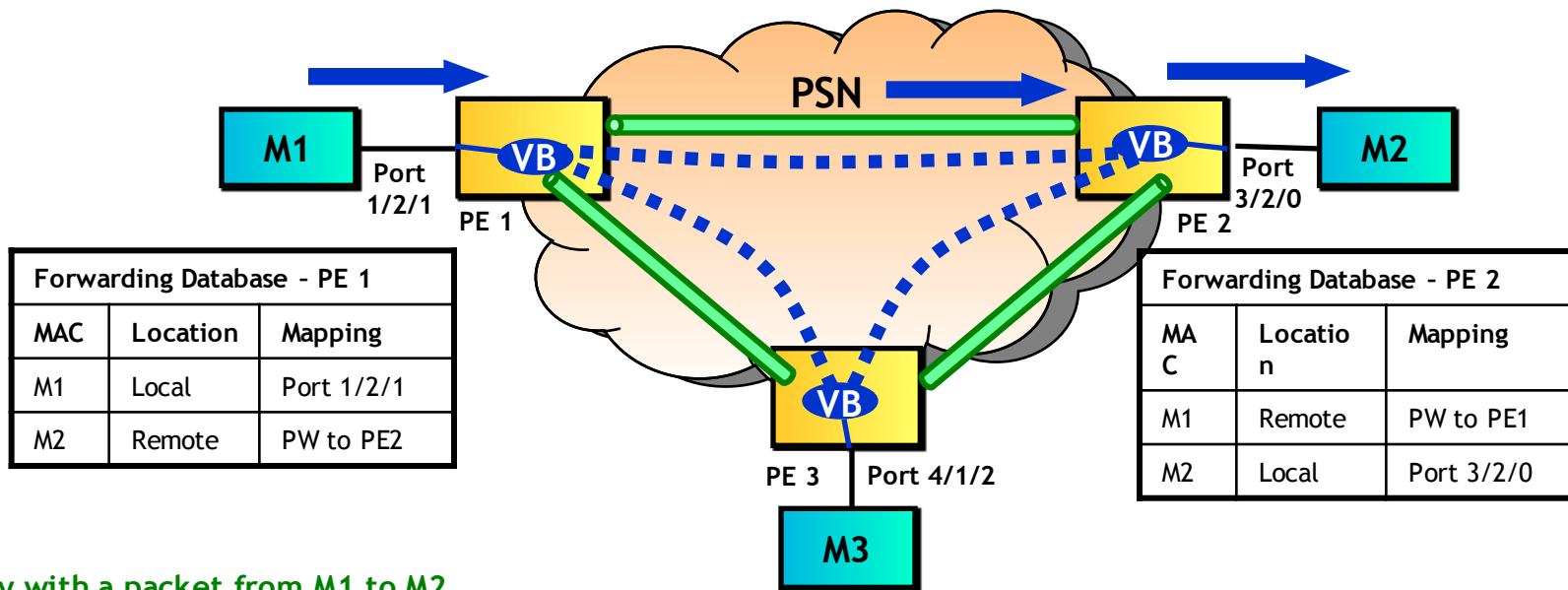

### Reply with a packet from M1 to M2

- PE1 learns M1 is on Port 1/2/1
- PE1 knows that M2 is reachable via PE2
- PE1 sends to PE2 using PW-label 6775
- PE2 knows that M2 is reachable on Port 3/2/0 and so it sends it out that port
- M2 receives packet

## Audience Question 6

---

**If a full-mesh VPLS is set up between 5 provider edge routers, how many pseudowires need to be configured ?**

---

## 4.5 Scaling VPLS

# Hierarchical-VPLS (H-VPLS)

- Introduces hierarchy in the base VPLS solution to provide scaling & operational advantages
- Extends the reach of a VPLS using spokes, i.e., point-to-point pseudowires or logical ports

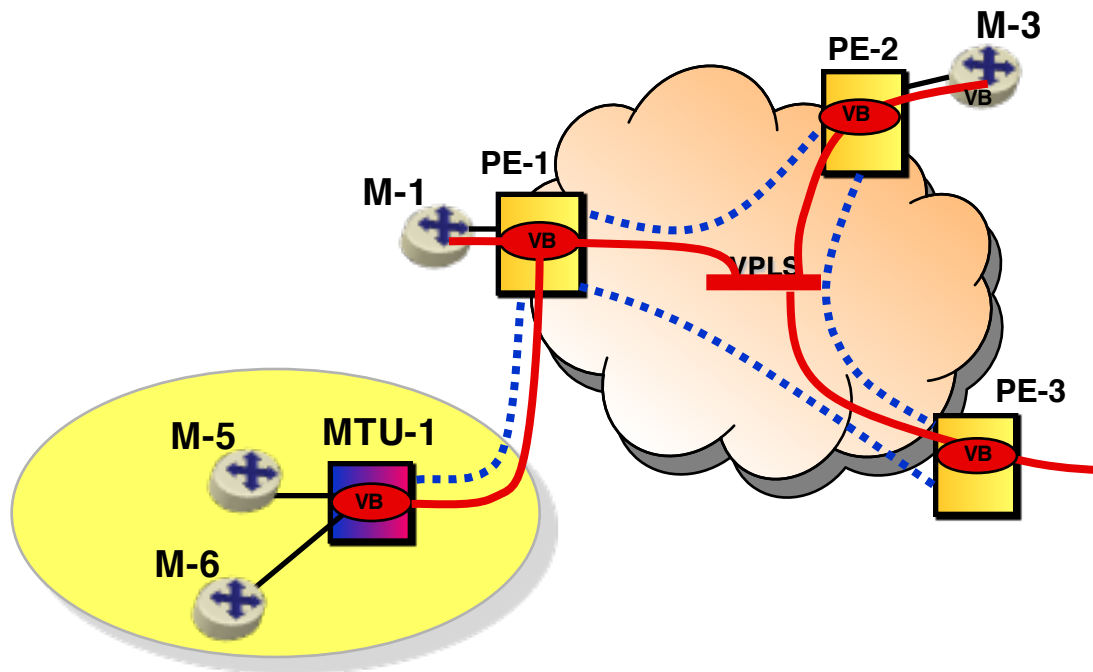

# Hierarchical VPLS

---

## How is a spoke useful?

- Scales signalling
  - Full-mesh between MTUs is reduced to full-mesh between PEs and single PW between MTU and PE
- Scales replication
  - Replication at MTU is not required
  - Replication is reduced to what is necessary between PEs
- Simplifies edge devices
  - Keeps cost down because PEs can be replaced with MTUs
- Enables scalable inter-domain VPLS
  - Single spoke to interconnect domains

# Scalability: Signalling

Full-mesh between PEs is reduced to full-mesh between PEs and single spoke between MTU and PE

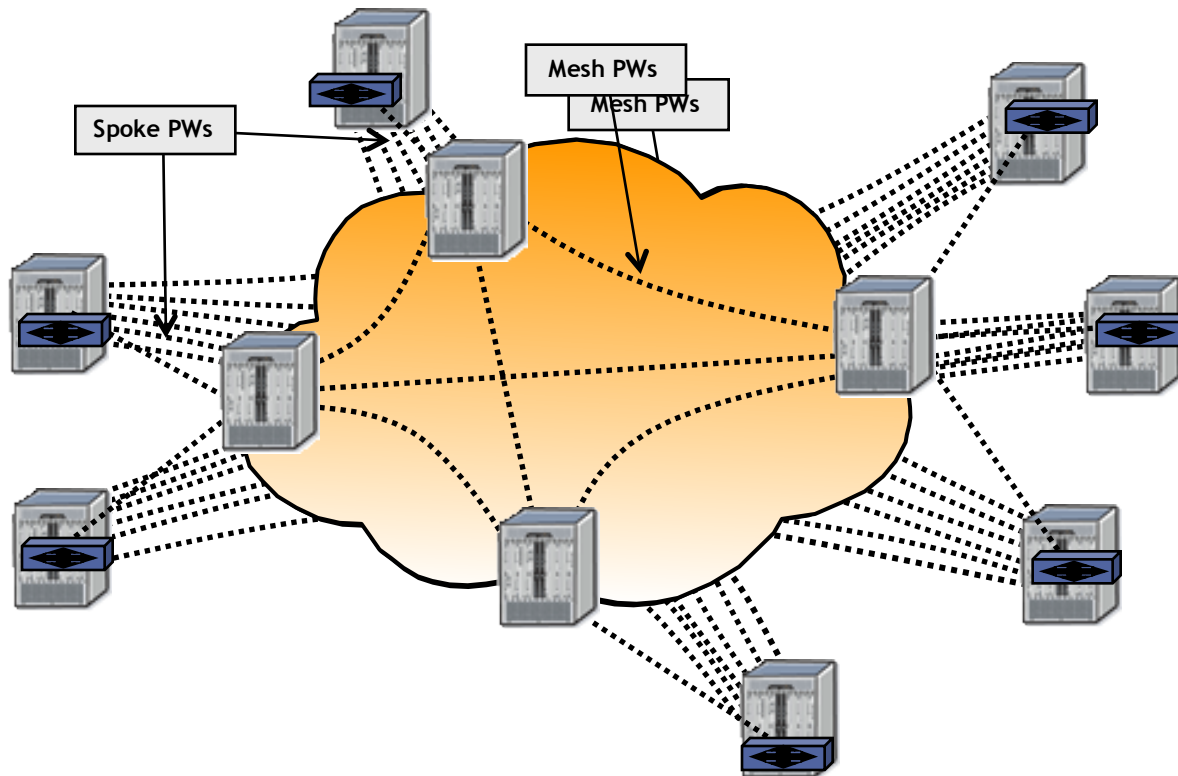

# Scalability: Replication

Flat architecture replication is reduced to distributed replication

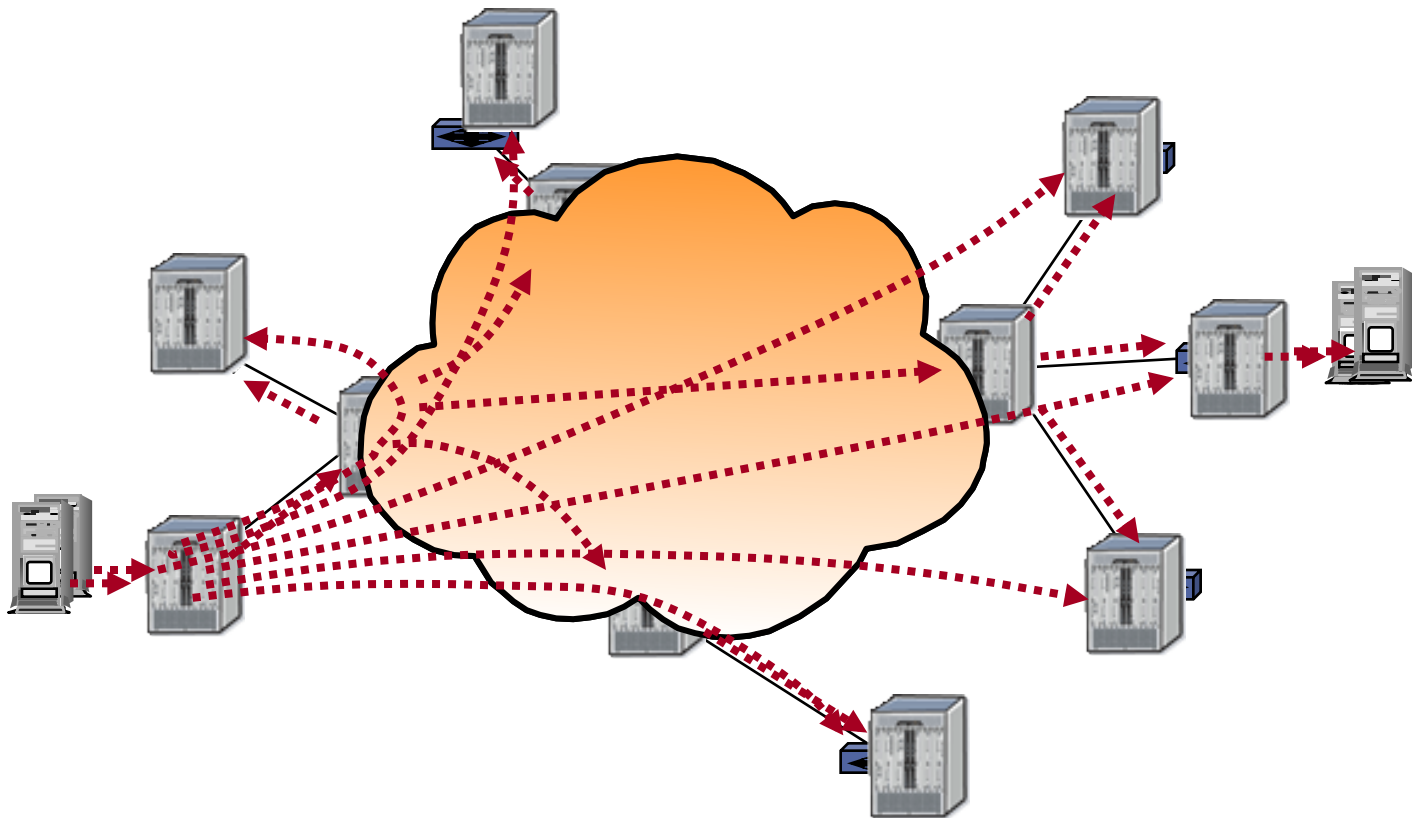



# Scalability: Configuration

Full mesh configuration

is significantly reduced

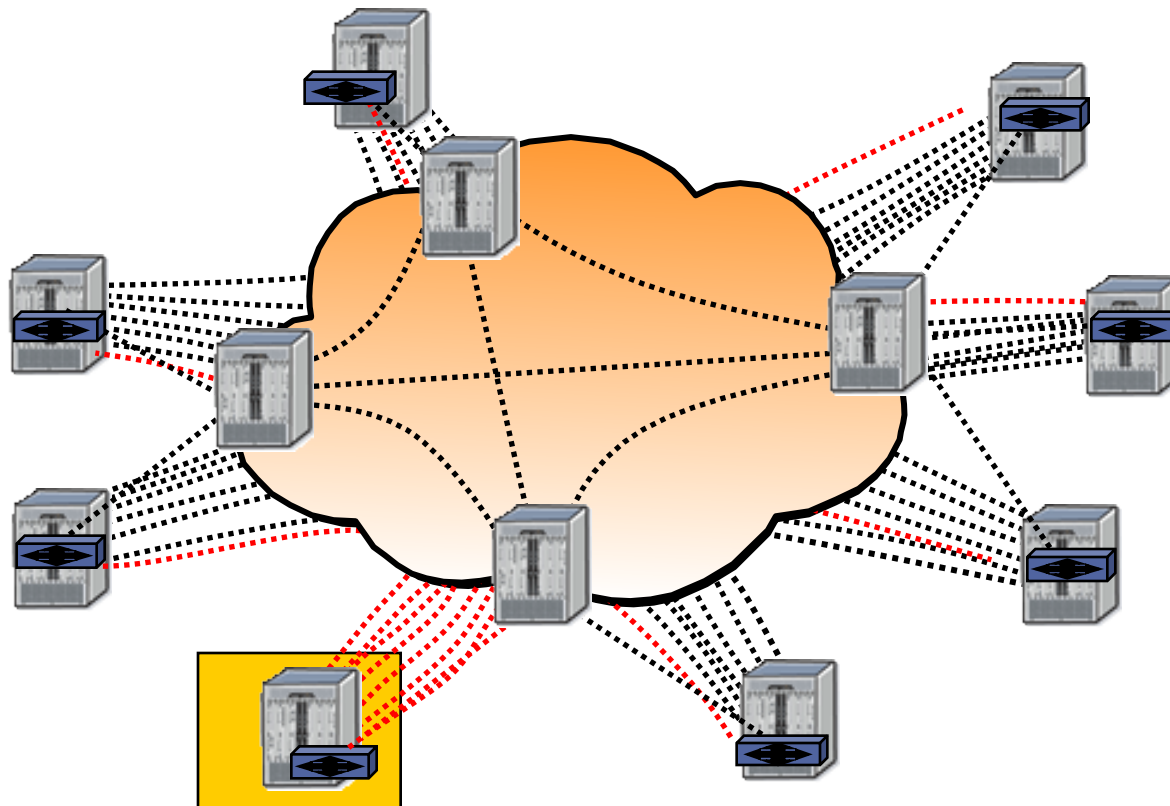

# Topological Extensibility: Metro Interconnect

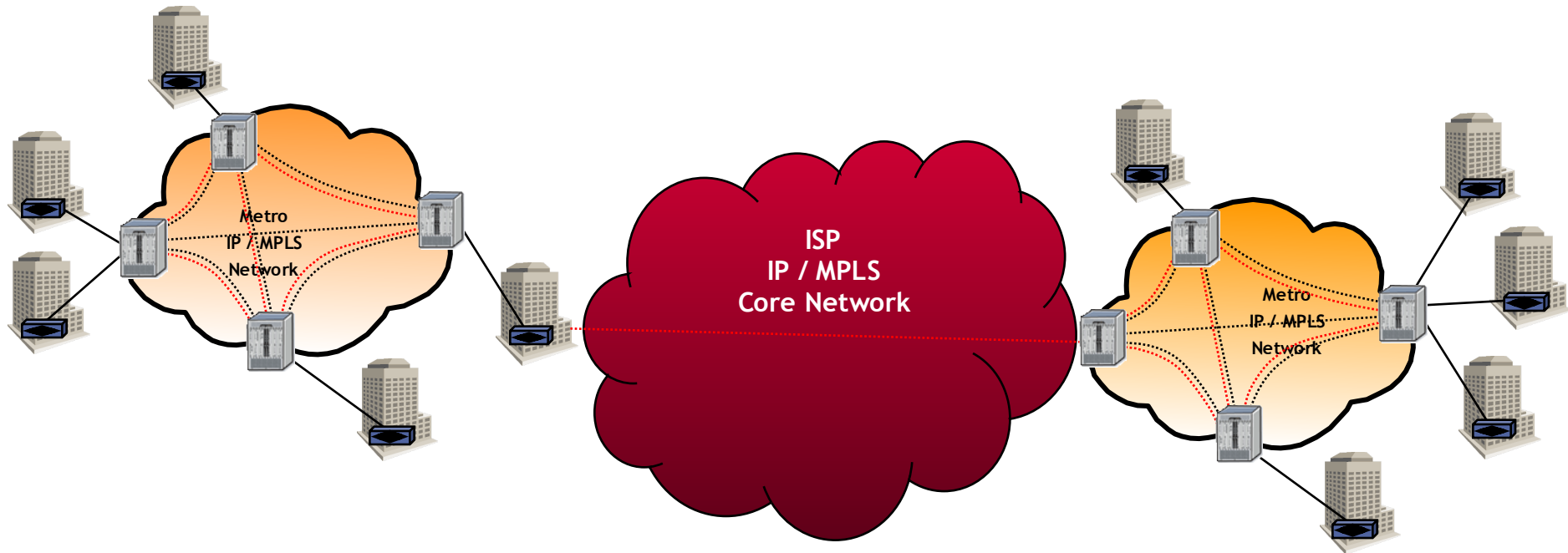

# Topological Extensibility: Inter-AS Connectivity

Provider hand-off can be

- q-tagged or q-in-q port
- Pseudowire spoke

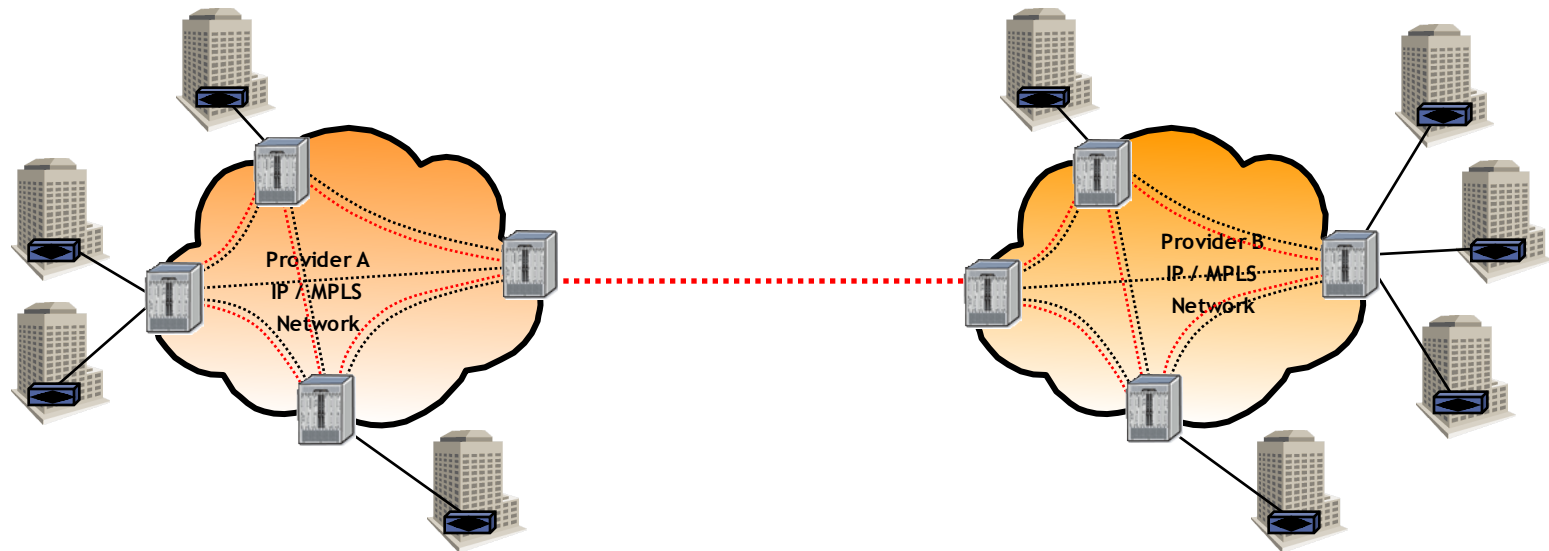

---

## 4.6 VPLS Topologies

# Topologies: Mesh

---

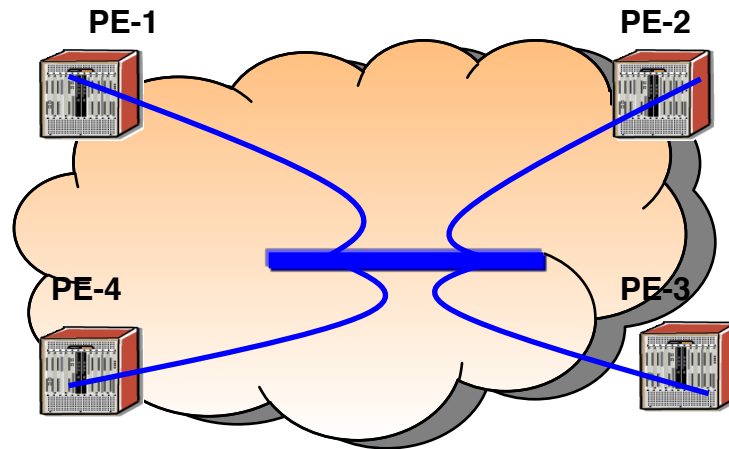

# Topologies: Hierarchical

---

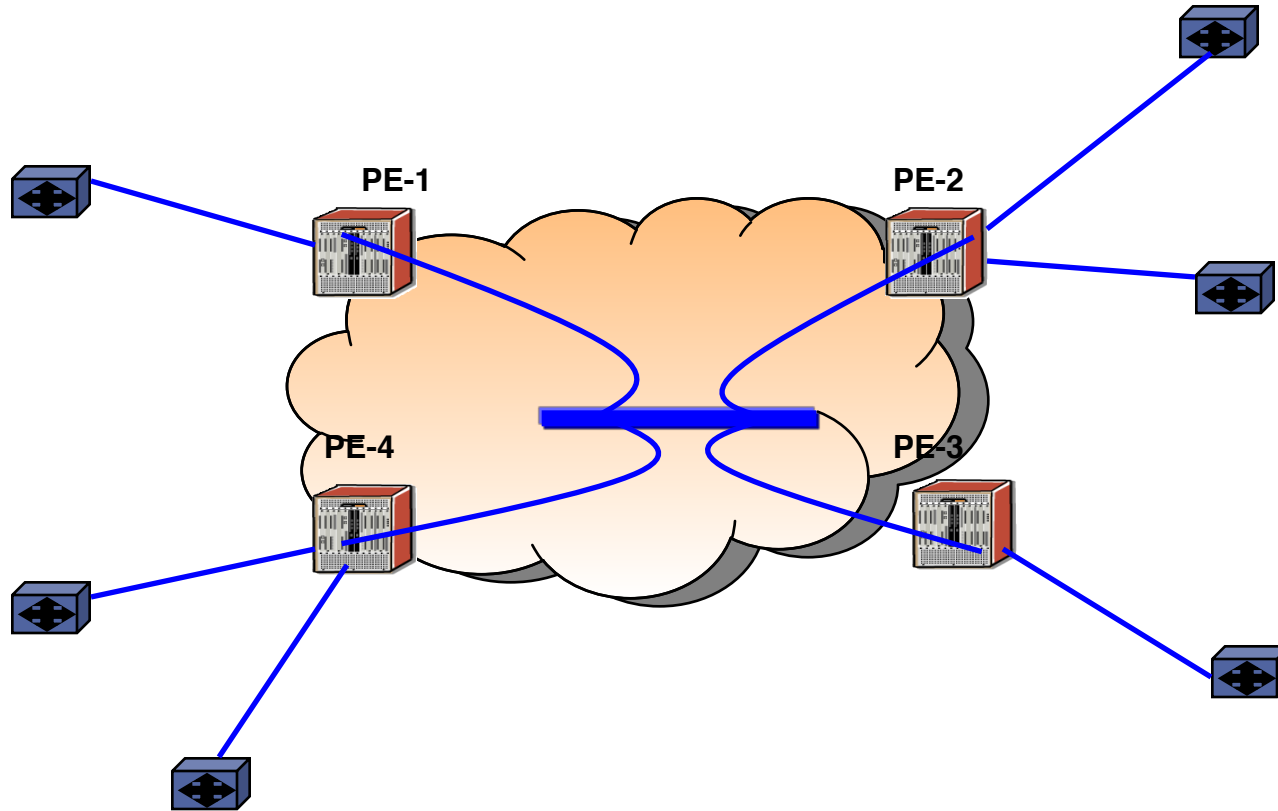

# Topologies: Dual-homing

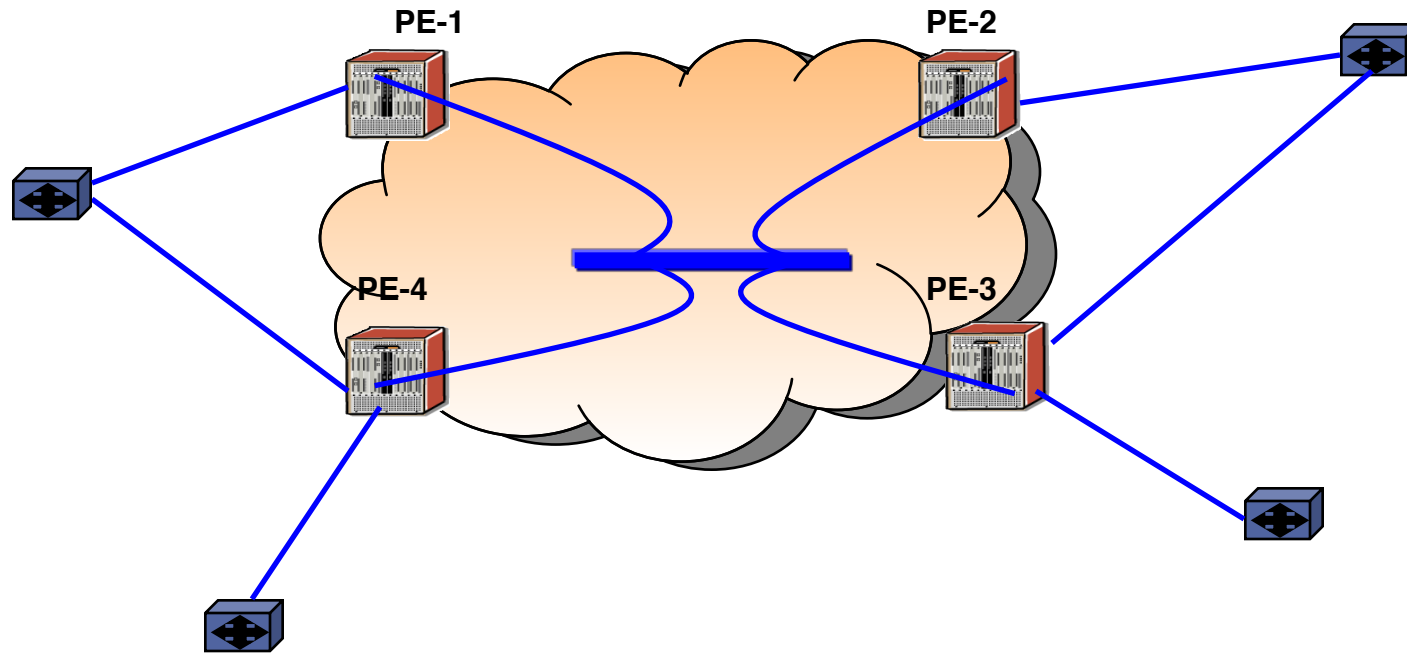

# Topologies: Ring

A full mesh would have too many duplicate packets

Each PE has a spoke to the next PE in the VPLS

Packets are flooded into the adjacent spokes and to all VPLS ports

When MACs are learned, packets stop at the owning PE

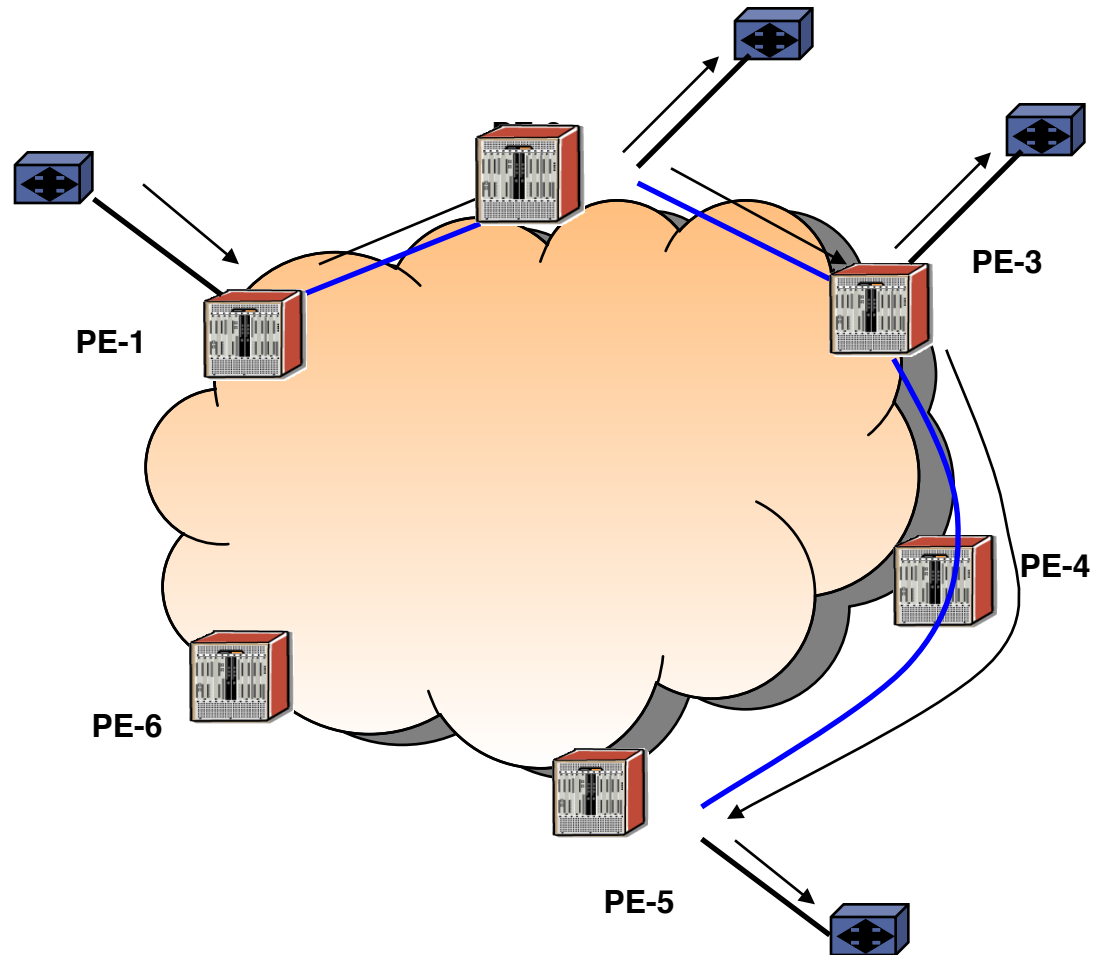



---

## 4.7 Resiliency Mechanisms

# Agenda

---

- 4.7. Resiliency Mechanisms
  - 4.7.1 Multi-Chassis LAG (MC-LAG)
  - 4.7.2 Redundancy with VPLS
  - 4.7.3 Pseudo-wire Redundancy with MC-LAG
  - 4.7.4 Multi-Segment Pseudo-wires

---

## 4.7.1 Multi-Chassis LAG (MC-LAG)

# Multi-chassis LAG: What is it ?

## Standard LAG

Traffic distributed via hash algorithm

- Maintains packet sequence per “flow”
- Based on packet content or SAP/service ID

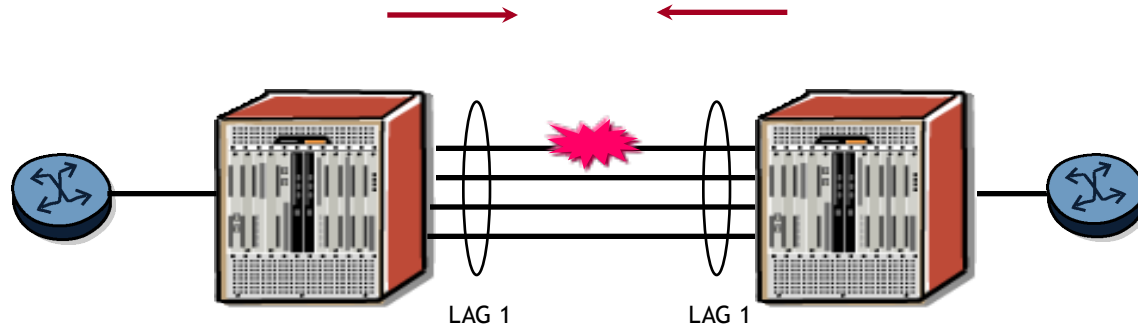

What if one system fails...

Introduce LAG redundancy to TWO systems

## Multi-Chassis LAG (MC-LAG)

# Multi-chassis LAG: How does it work ?

## Multi-chassis LAG

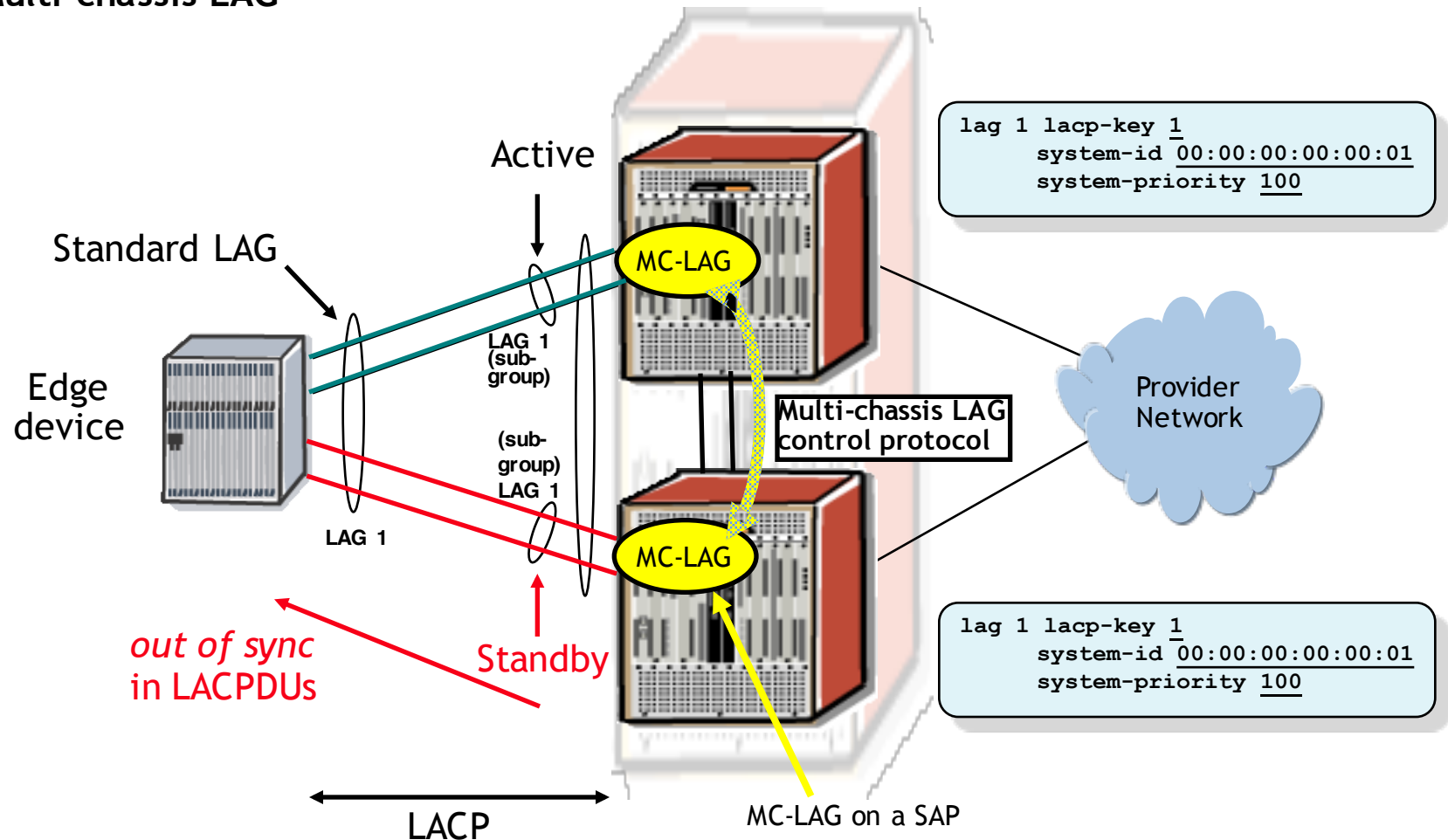

# Multi-chassis LAG: How does it work ?

## Multi-chassis LAG failover

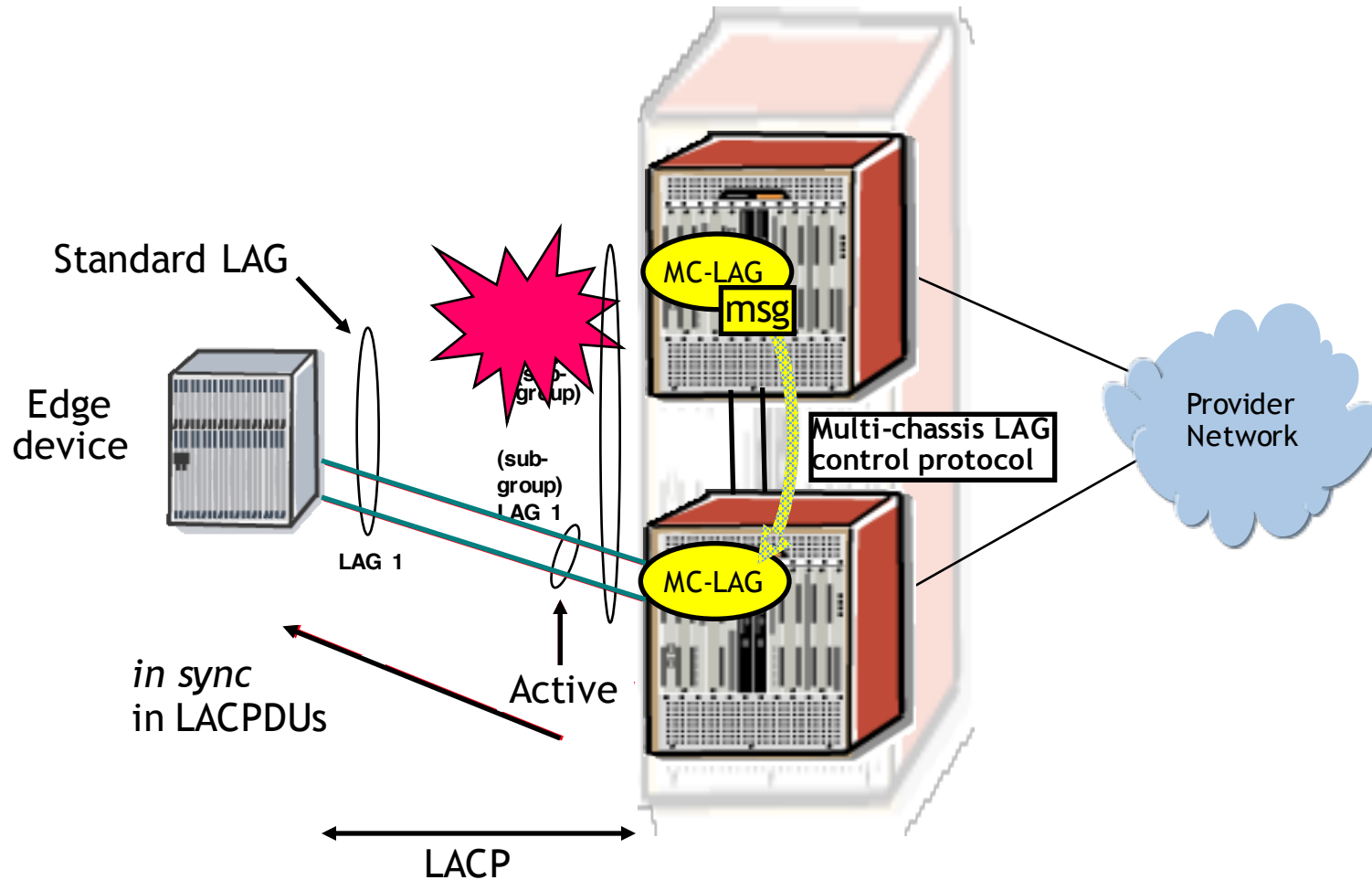

---

## 4.7.2 Redundancy with VPLS

# Redundancy at the VPLS edge: MC-LAG

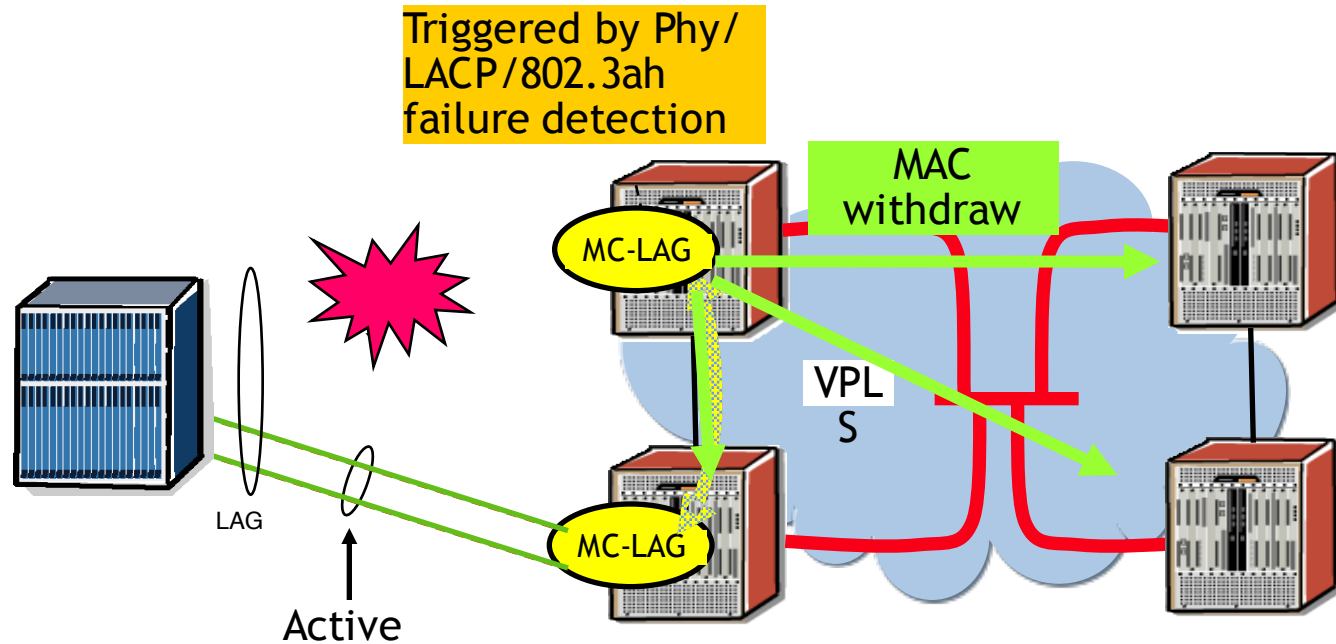



# Redundancy Applications for VPLS w/MC-LAG

## Network Edge

L2/L3 CPE for business services

L2 DSLAM/BRAS for triple-play services

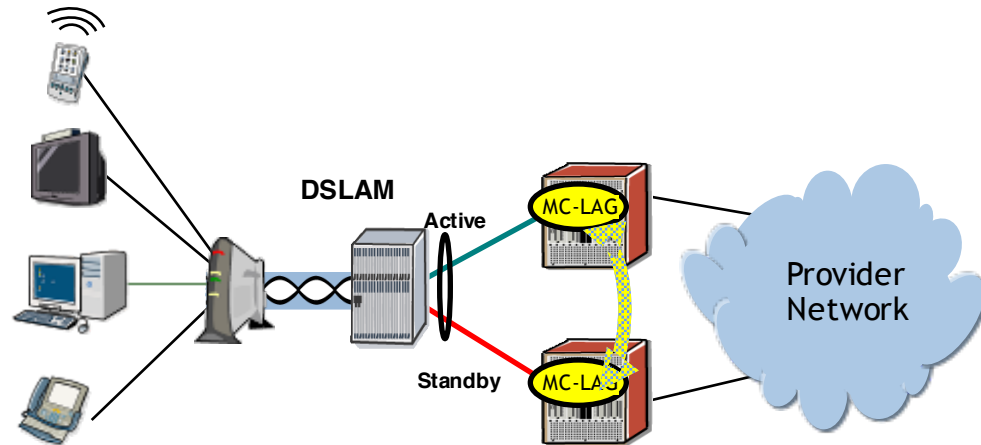
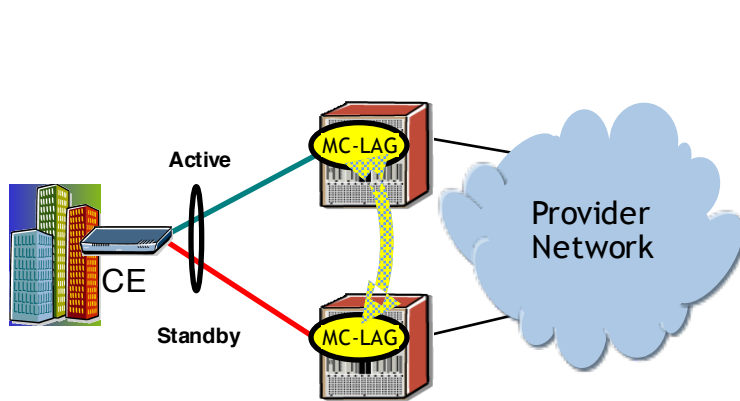

## Inter-metro Connectivity

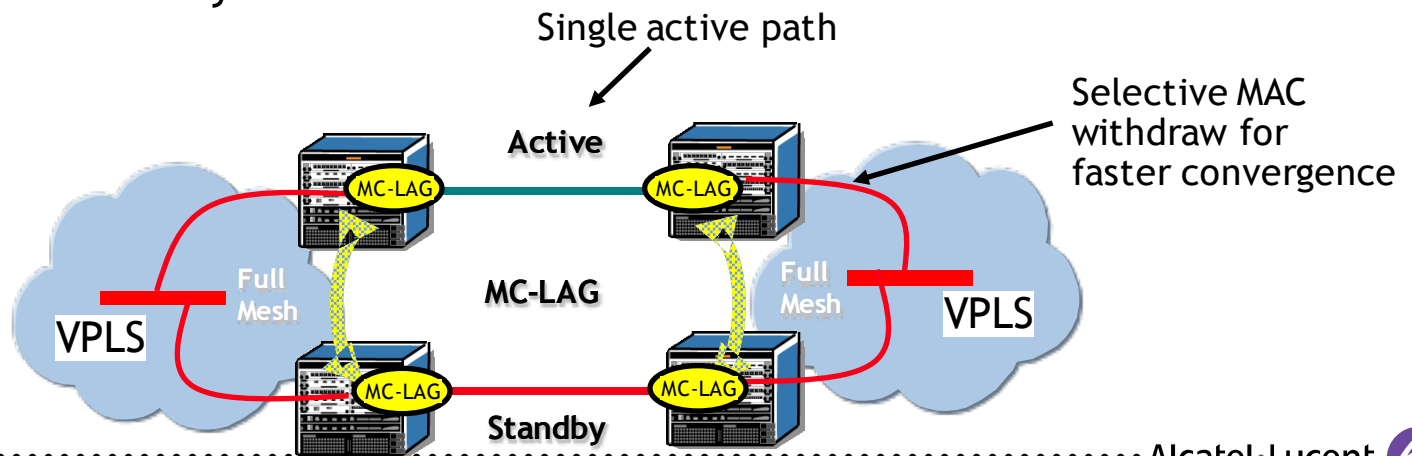

---

## 4.7.3 Pseudo-wire Redundancy with Multi-chassis LAG

# Pseudowire Redundancy

- VLL
- Tunnel redundancy

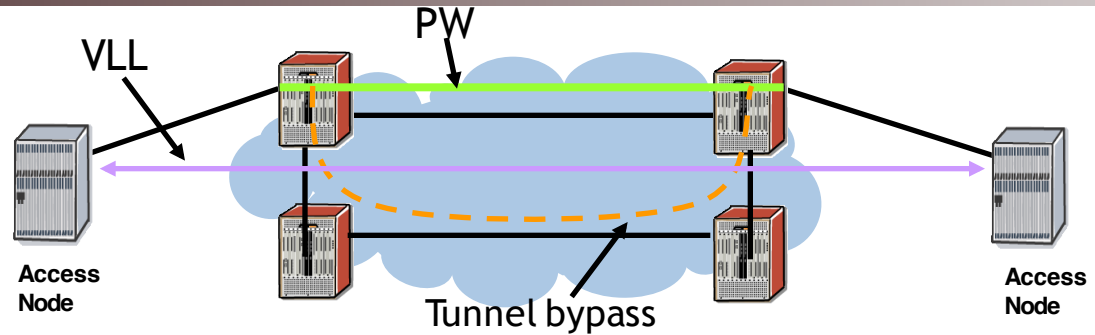

- VLL
- PW redundancy
  - Single edge redundancy

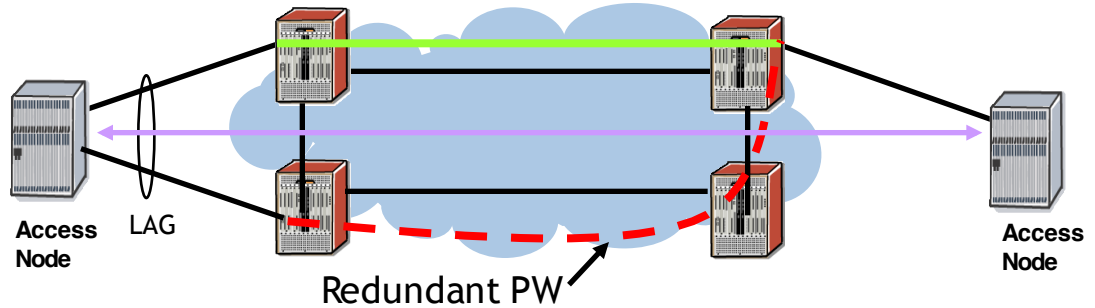

- VLL
- PW redundancy
  - Dual edge redundancy

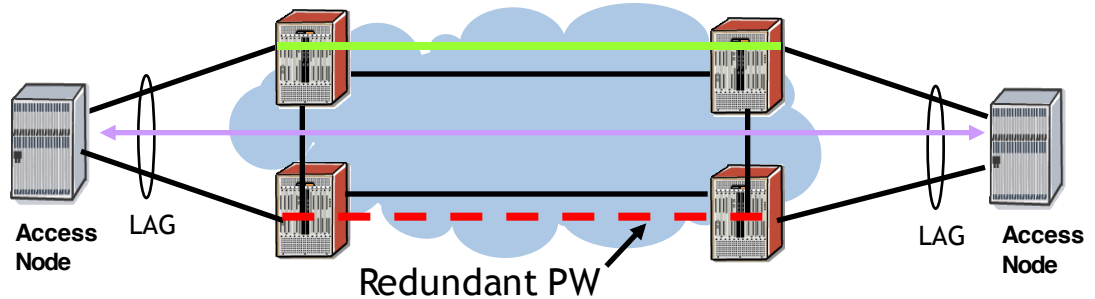

# Combining MC-LAG with Pseudowire Redundancy

Extends L2 point-to-point redundancy across the network

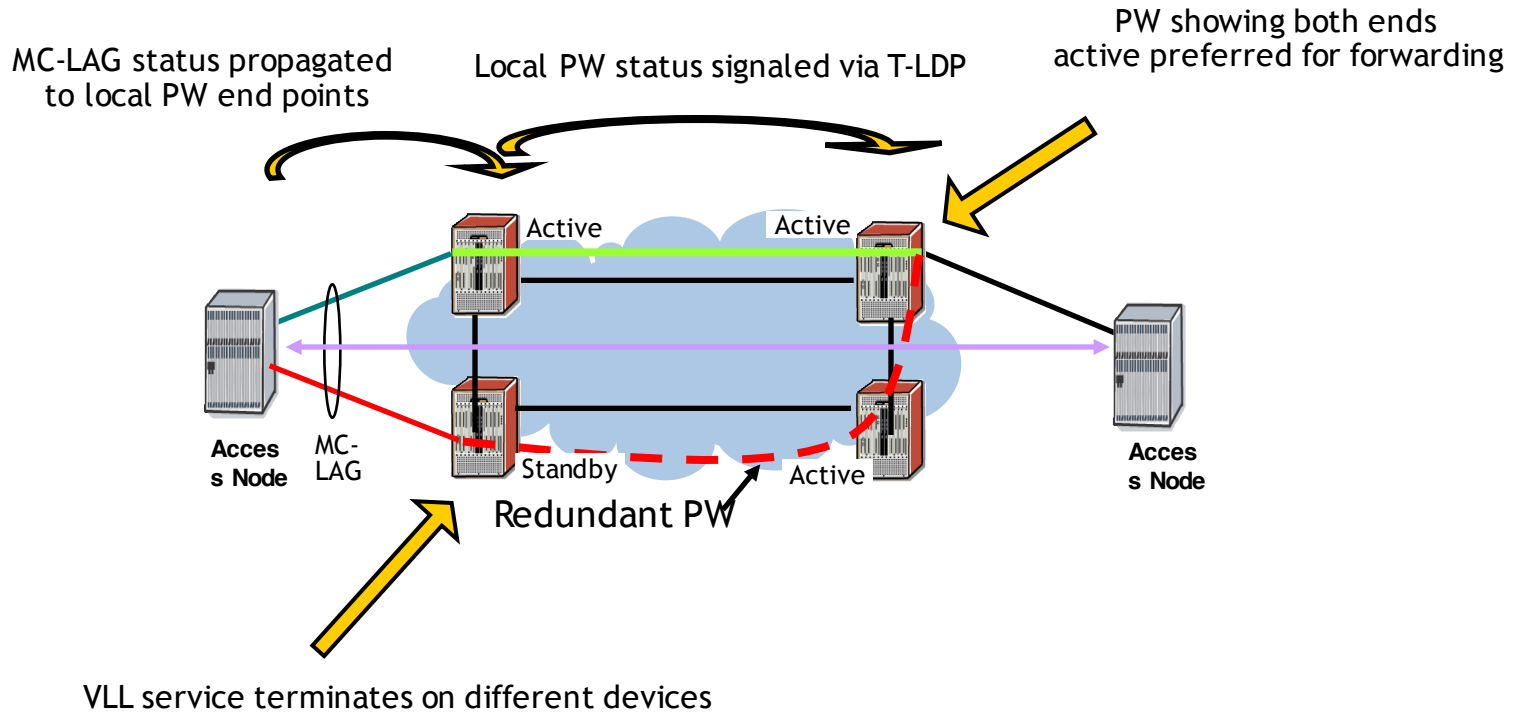

# Multi-chassis LAG with Pseudo-Wire Redundancy: How does it work ?

## VLL

- PW redundancy
- Single edge redundancy

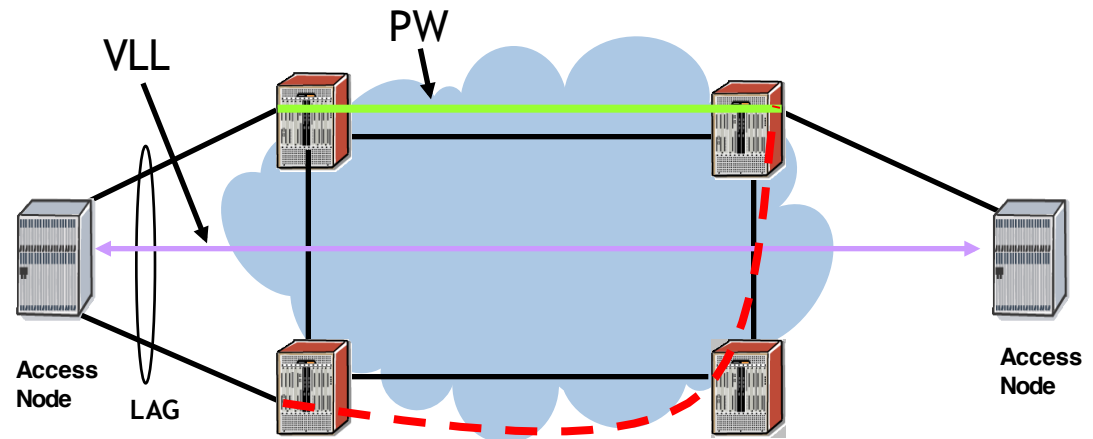

# Multi-chassis LAG with PW Redundancy: How does it work ?

## LAG to PWs

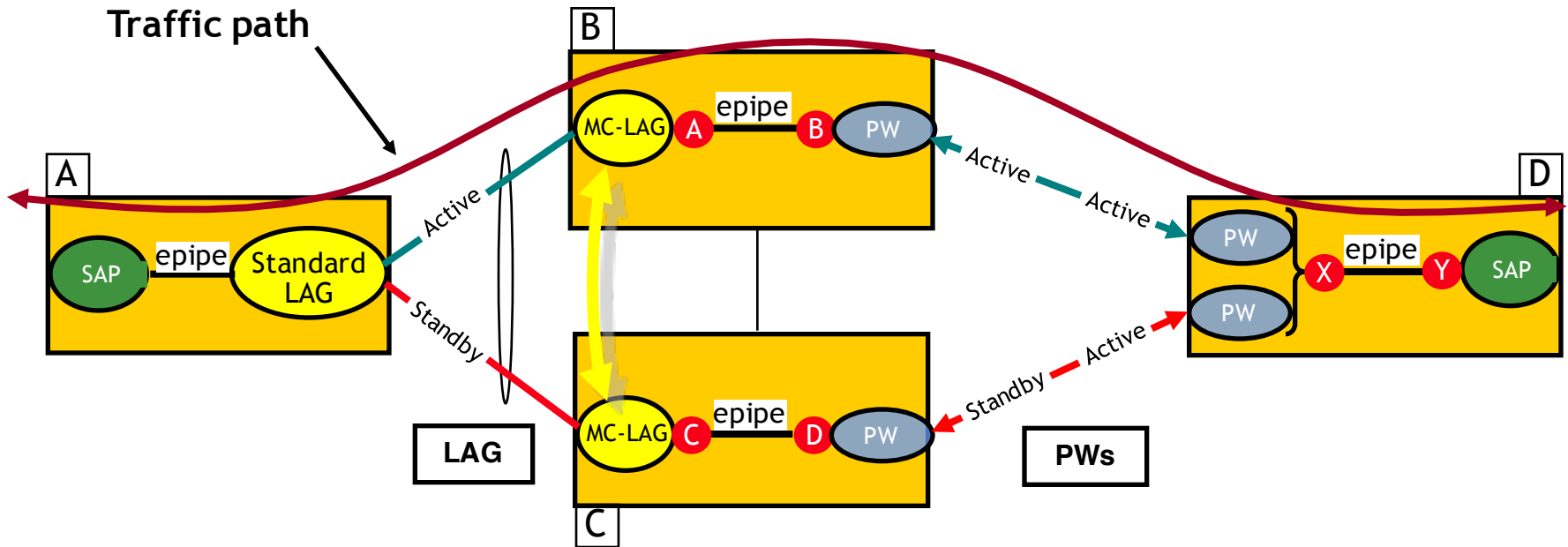

# Multi-chassis LAG with PW Redundancy: How does it work ?

LAG to PWs : LAG link failure

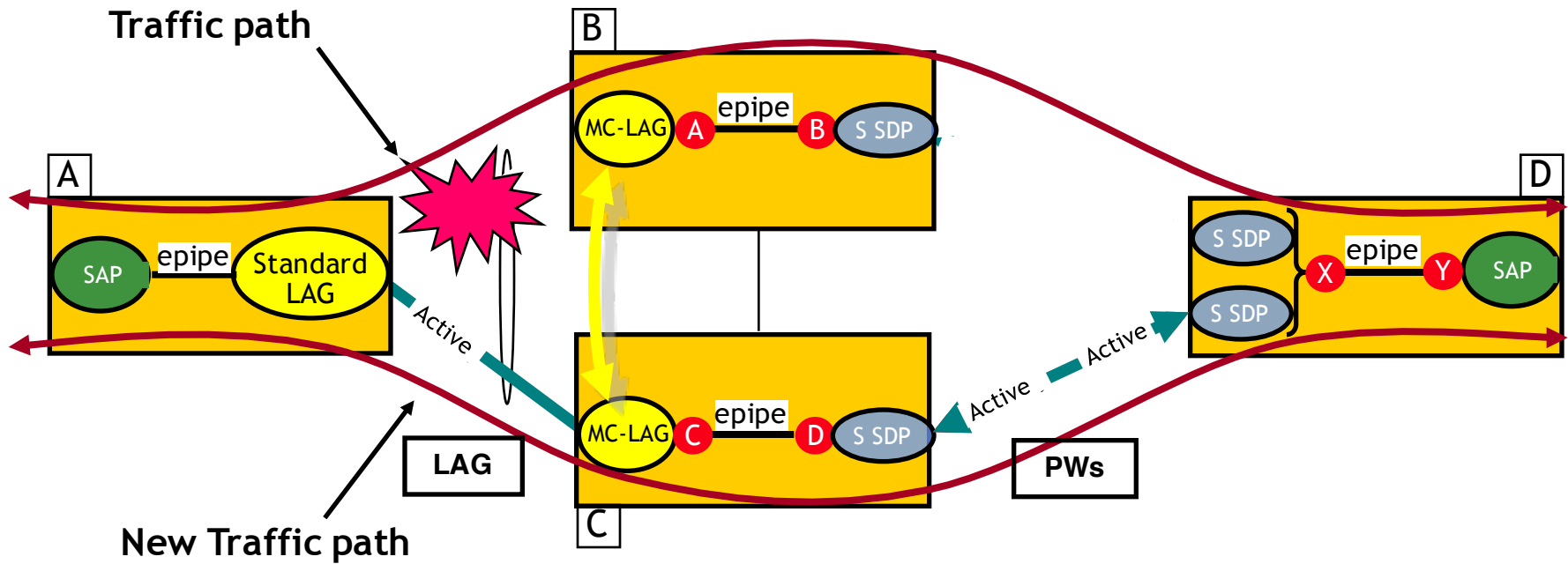

# Multi-chassis LAG with Pseudo-Wire Redundancy: How does it work ?

## VLL

- PW redundancy
- Dual edge redundancy

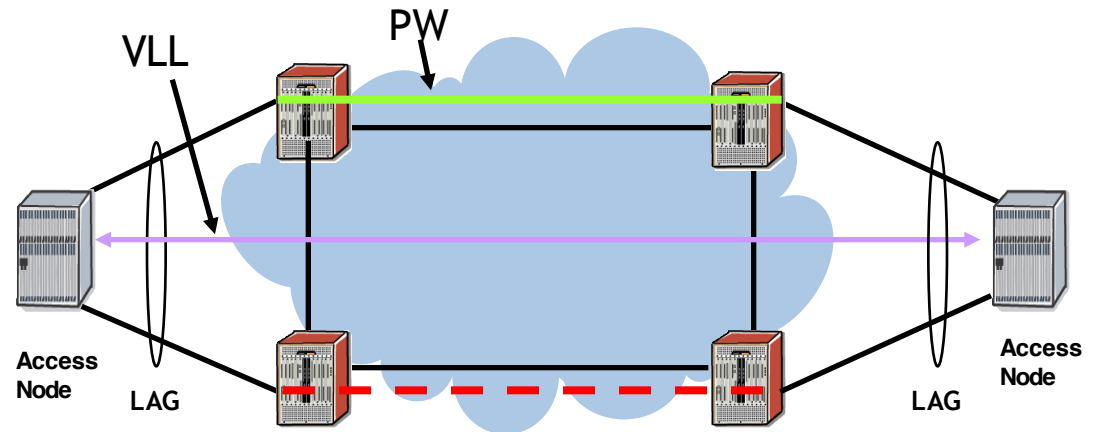



# Multi-chassis LAG with PW Redundancy: How does it work ?

## LAG to PWs to LAG

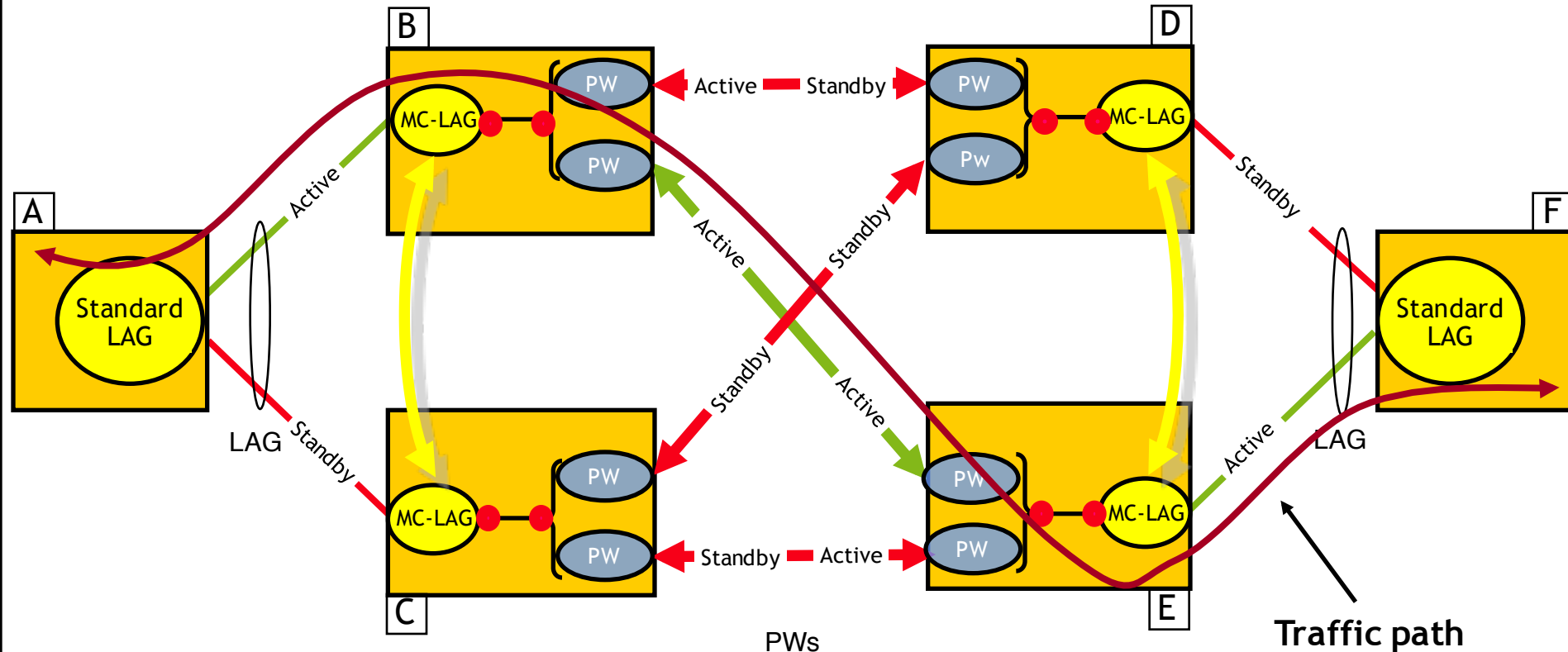

# Multi-chassis LAG with PW Redundancy: How does it work ?

## LAG to PWs to LAG : Network device failure

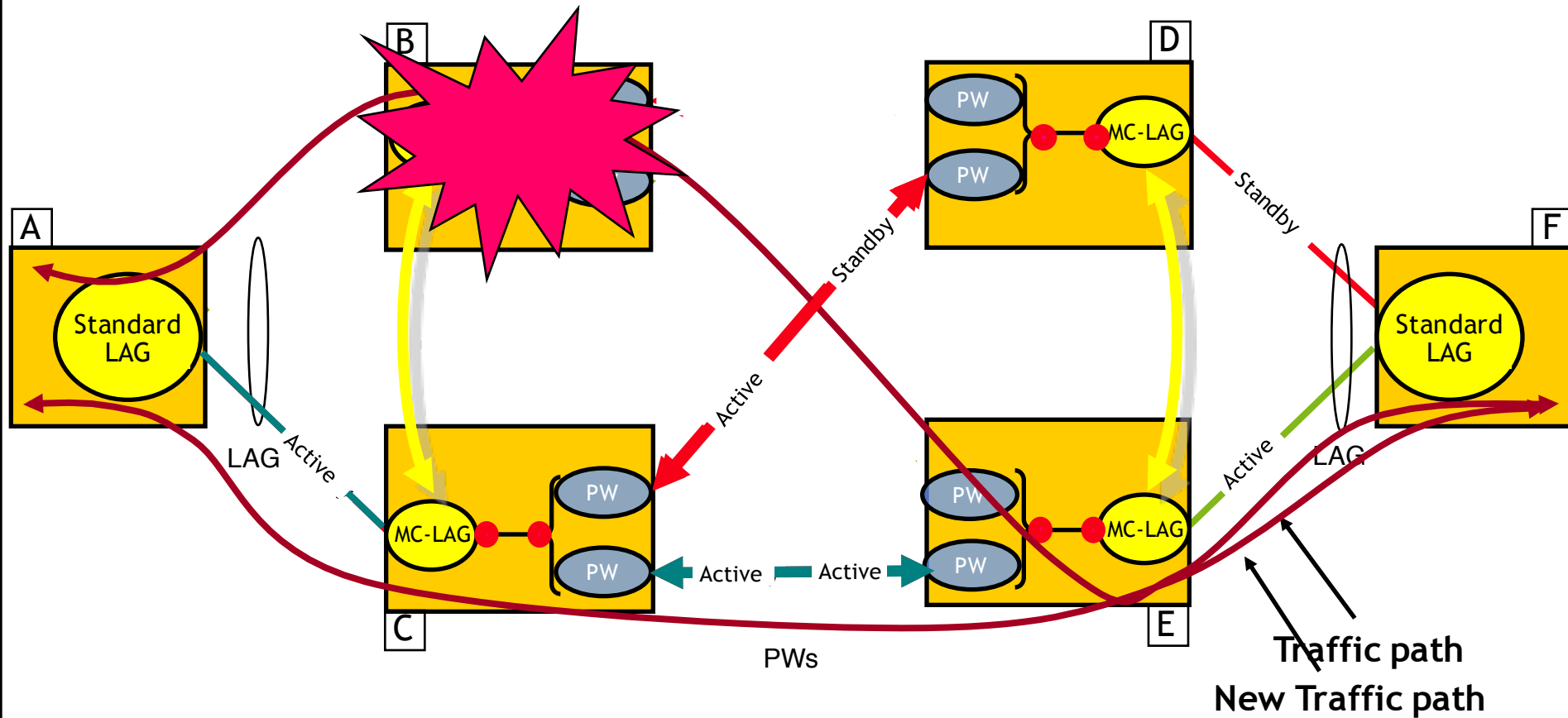

---

## 4.7.4 Multi-segment Pseudo-wires

# Multi-segment Pseudo-wire - Motivation

## Ethernet VLL with SS-PW

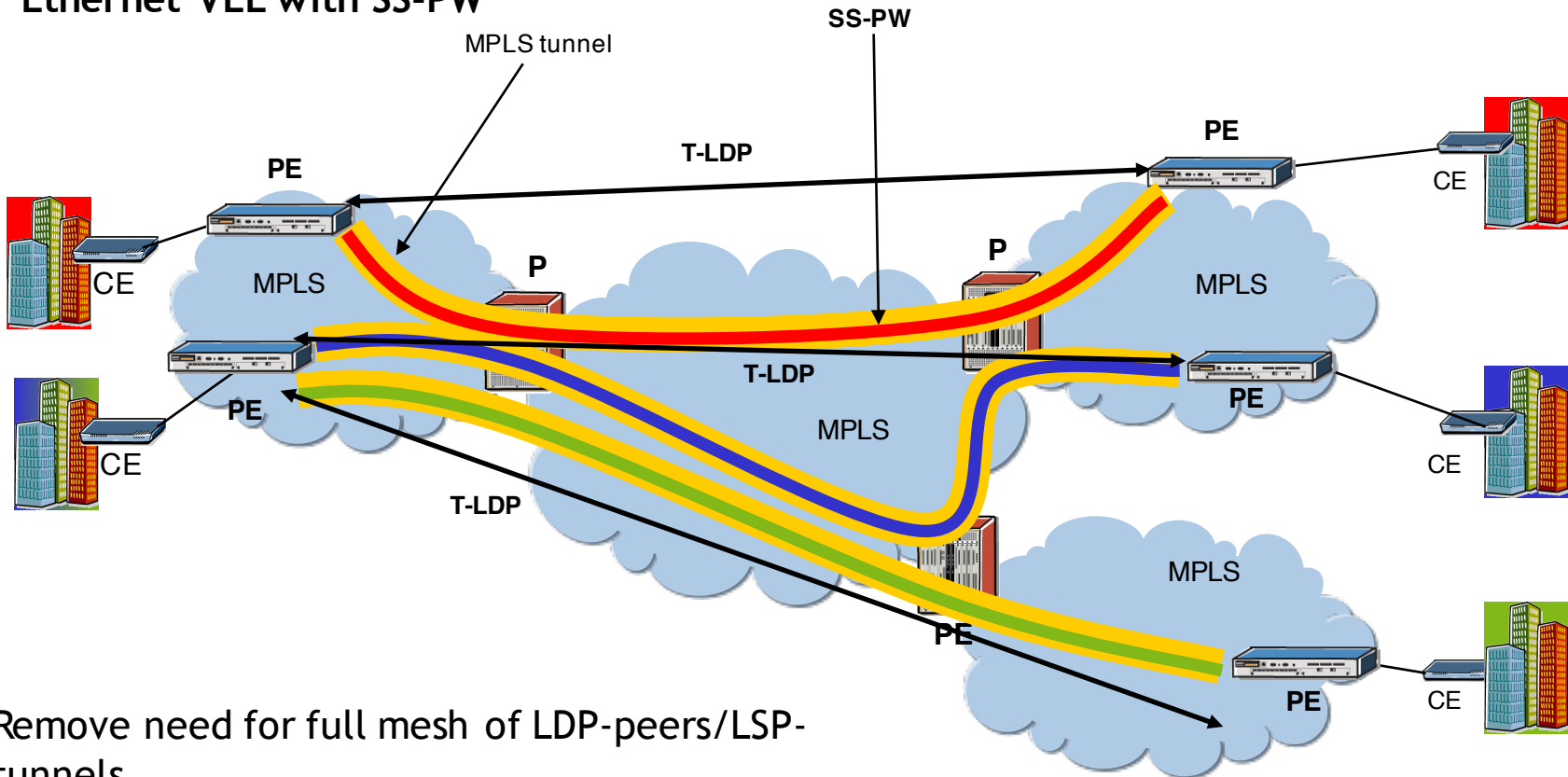

Remove need for full mesh of LDP-peers/LSP-tunnels

VLLs over multiple tunnels (of different types)

Simplifying VLL provisioning

# Multi-segment Pseudo-wire - How can you use them ?

## Ethernet VLL with MS-PW

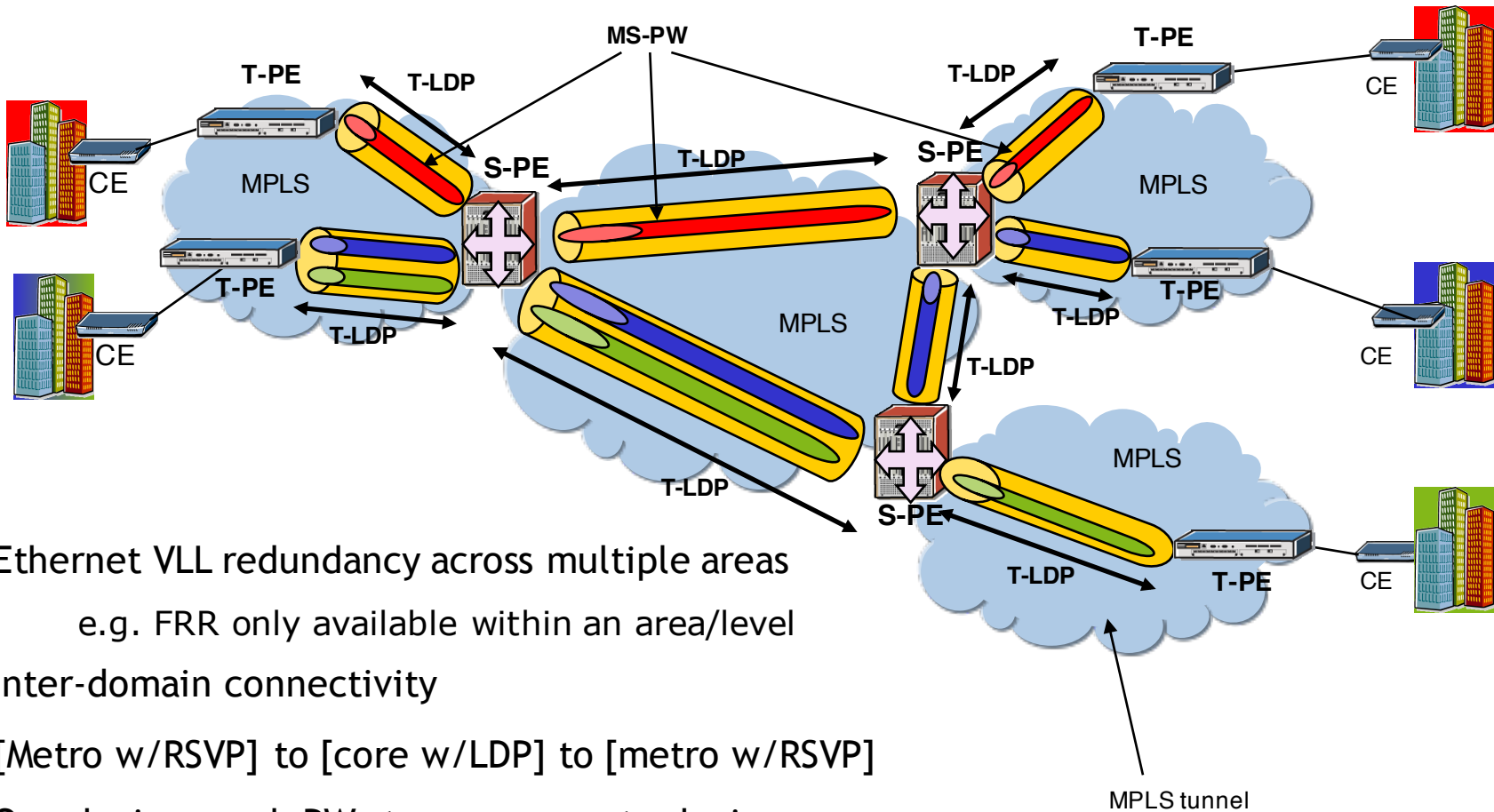

Ethernet VLL redundancy across multiple areas

e.g. FRR only available within an area/level

Inter-domain connectivity

[Metro w/RSVP] to [core w/LDP] to [metro w/RSVP]

One device needs PWs to many remote devices



# Multi-segment Pseudo-wire - How do they work ?

Single Segment PW

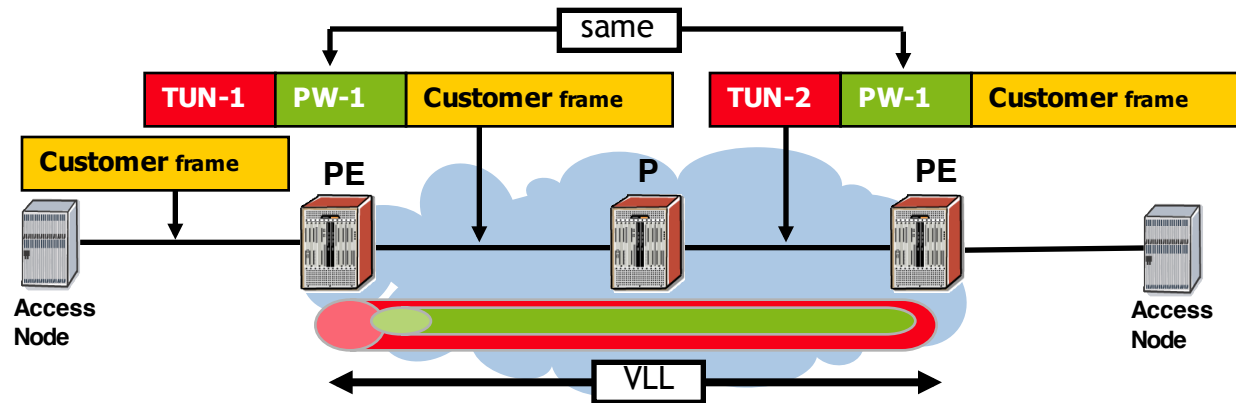

Multi Segment PW

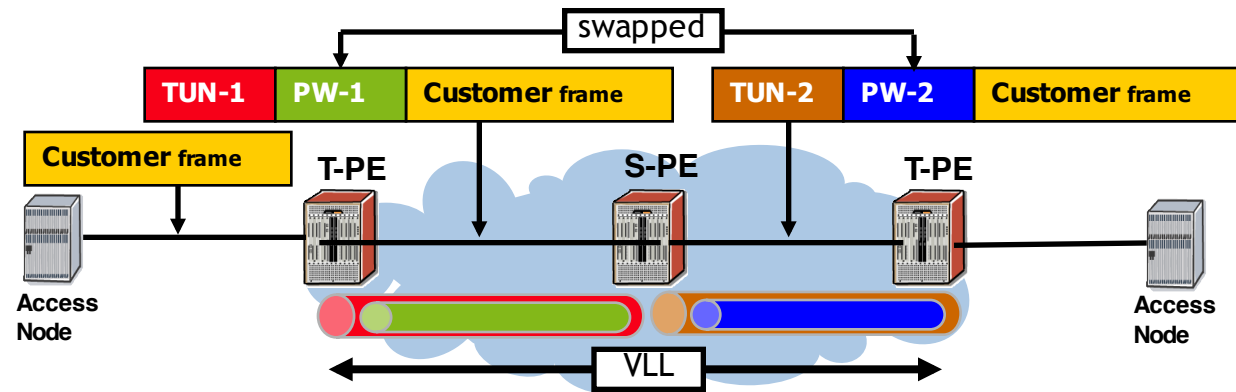

# Multi-segment Pseudo-wire - Redundancy

## Inter-metro/domain Redundant Ethernet VLLs with MS-PW

- Individual segments can have MPLS (FRR...) protection
- Configure parallel MS-PW for end-end protection

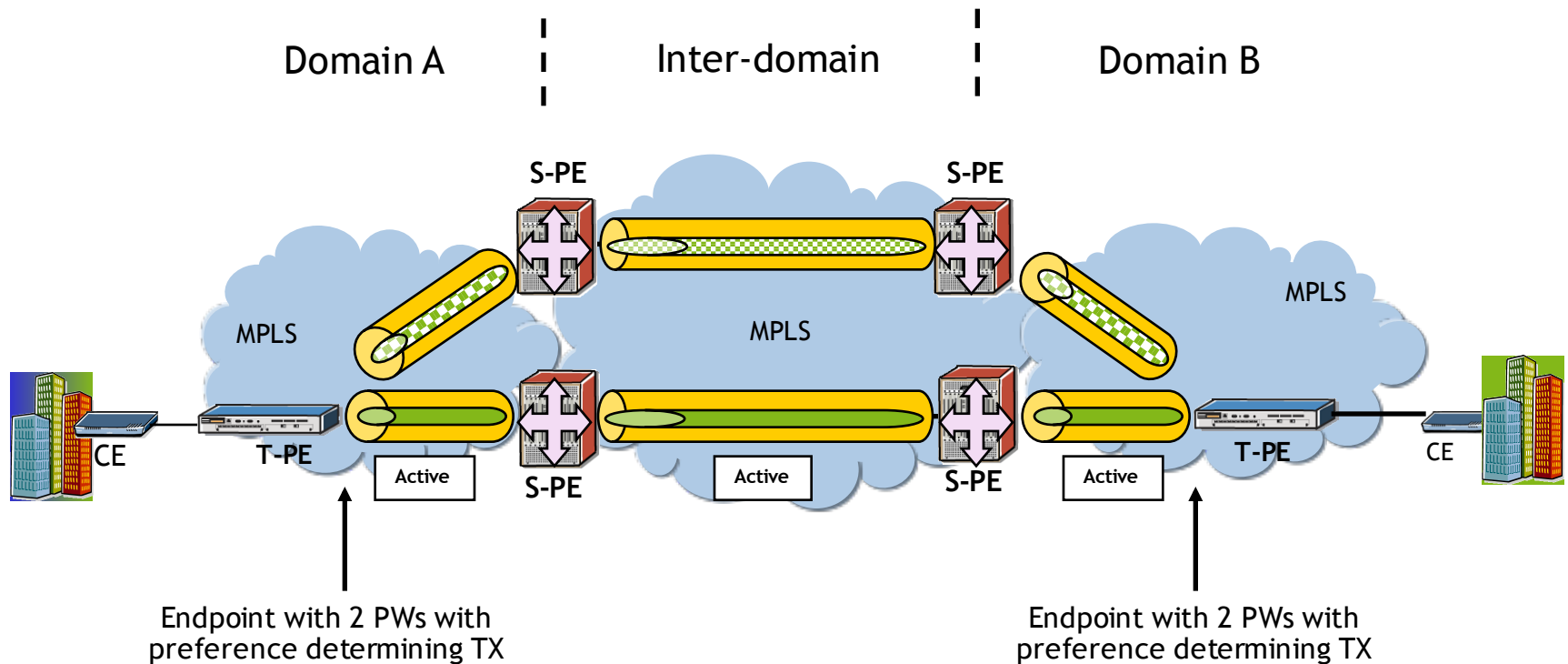



# 5. Summary



# Summary

---

- Ethernet Services are in a period of tremendous growth with great revenue potential for service providers
- The Metro Ethernet Forum has standardised Ethernet services and continues to enhance specifications
- Traditional forms of Ethernet delivery are no longer suitable for the delivery of “carrier-grade” Ethernet services
- MPLS provides a proven platform for the delivery of scalable, flexible, feature-rich Ethernet services using the same infrastructure used to deliver other MPLS-based services

---

## 6. Questions ???

---

# Thank You

---

[www.alcatel-lucent.com](http://www.alcatel-lucent.com)

